



## SW180 AND SW190 SERIES OF D.C. CONTACTORS



**SW180**  
Single pole on/off  
contactor



**SW181**  
Single pole changeover  
contactor



**SW182**  
Paired changeover  
contactor

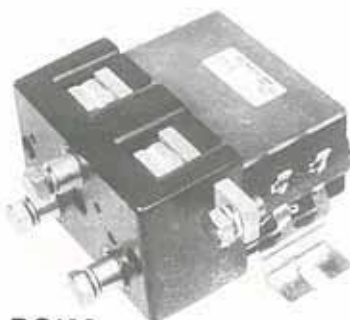

**DC182**  
Monoblock single pole  
double throw contactor



**SW190**  
Double pole  
on/off contactor



**SW192**  
Paired double pole  
on/off contactor

### UNIQUE RANGE

The SW180 series of contactors has been designed for direct current loads, particularly motors as used on electric vehicles such as industrial trucks, airport tractors, etc.

They have double breaking main contacts with silver alloy contact tips, which are weld resistant, hard wearing and have excellent conductivity.

The range comprises: Single Pole, on/off types (SW180), Double Pole, on/off types (SW190), Single Pole, changeover types (SW181), Single Pole, normally closed types (SW185) and paired versions of these for motor reversing (SW182, DC182 and SW192).

### COMPACT SIZE

The contactors are compact in size and are fully serviceable, with a full range of spare parts available.

### EASY INSTALLATION

Mounting is by means of 5mm tapped holes in the switch frame together with a range of mounting brackets complete with screws and washers.

Coil connections are by means of 6mm spades of which two are supplied per terminal.

Contactors types SW182, DC182, SW184, DC184, SW189 and SW192 are supplied as an assembly which includes a mounting bracket as a standard feature.

Mounting attitudes are detailed in the drawings on the following pages.

### OPERATING COILS

Coil voltages ranging from 6 to 240 are available and these are wound for D.C. operation.

However coils can be fitted with a bridge rectifier for use from A.C. supplies.

Coils are normally wound for intermittent duty (up to 70% "on" time) but continuous duty version (100%) are also available.

### CONTACTORS IN THE SERIES

**SW180** SINGLE POLE SINGLE THROW

**SW181** SINGLE POLE DOUBLE THROW

**DC182** MONOBLOCK SINGLE POLE DOUBLE THROW (for motor reversing)

**SW182** PAIRED SINGLE POLE DOUBLE THROW ON DOUBLE BRACKET (for motor reversing)

**DC184** MONOBLOCK 2 x SW180

**SW184** 2 x SW180 ON DOUBLE BRACKET

**SW185** SINGLE POLE SINGLE THROW (normally closed)

**SW189** 2 x SW185 ON DOUBLE BRACKET

**SW190** DOUBLE POLE SINGLE THROW

**SW192** PAIRED DOUBLE POLE SINGLE THROW (for motor reversing)

**DIMENSION DRAWINGS**



The contactors can be mounted either horizontally or vertically. If mounted vertically the contact studs must point upwards with the exception of the SW185 and its derivatives which should be mounted with the contact studs pointing downwards.

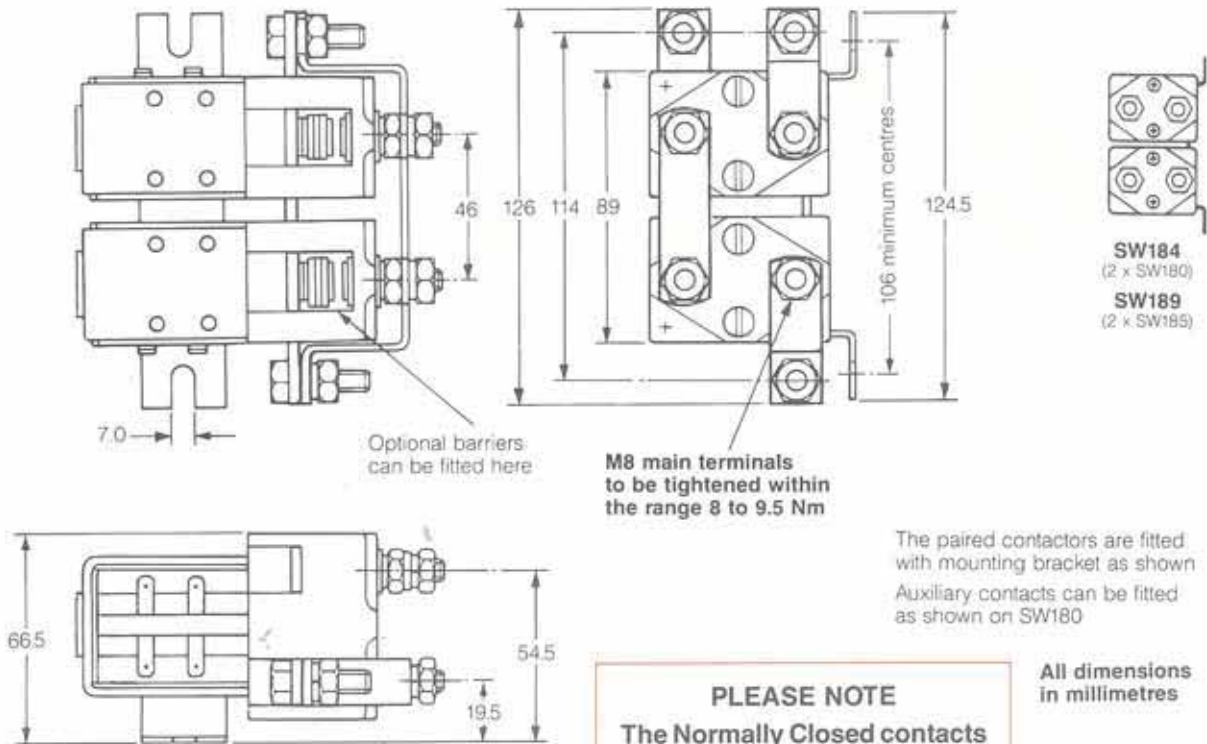

**SW182, SW184 AND SW189**

## DIMENSION DRAWINGS



### SW190

The contactors can be mounted either horizontally or vertically. If mounted vertically the contact studs must point upwards.



### SW192

Pull-in voltages are approximately 60% and 66% of the rated voltage for intermittent and continuously rated types respectively.

Drop out voltage is nominally 10% of rated voltage.

Variations from these pull-in and drop-out figures can be engineered to suit particular applications.

## CONTACTOR PAIRS

The contactors can be mounted in pairs on a common bracket together with inter-connecting electrical links. The most important of these arrangements are the motor reversing circuits provided by the SW182, DC182 and SW192 contactor pairs.

The SW182 and DC182 types have a built in failsafe so that if both coils are energised simultaneously the contact design creates an open circuit situation.

The SW192 types have fast drop-out times (approx 5 m.sec.) and relatively slow pull-in times (approx 20 m.sec). Therefore motor direction changes can be undertaken without risk of all contacts being closed at the same time. However, certain types of coil suppression, such as diodes, substantially increase drop-out times and care must be taken to ensure suitable suppression is fitted, e.g. diode and resistor in series.

## MAGNETIC BLOWOUTS 'B'

The contactors can be fitted with permanent magnet blowouts. These enable the contacts to switch D.C. voltages of 48 or higher. Fitting of blowouts to single pole types makes the contacts polarity sensitive and the **Positive markings** on the top cover of the contactor **must** be observed.

Double pole types are not polarity sensitive when blowouts are fitted.

The suffix 'B' denotes the fitting of magnetic blowouts, for example SW180B.

## AUXILIARY CONTACTS 'A'

A double circuit normally open, normally closed microswitch can be fitted which has a D.C. resistive rating of 5 Amperes at 24v.

The suffix 'A' should be added to the type number when an auxiliary

contact is required, for example, SW180A.

Note: Auxiliary contacts cannot be fitted to the SW192 type.

### LARGE CONTACTS 'L'

The SW180 range of contactors have standard contacts which are 10.3 mm diameter. These are suitable for

the majority of applications where switching conditions are relatively light, particularly on electronically controlled vehicles. However, in applications where more severe conditions exist, e.g. pump motor switching, all types are available with larger contacts 15.2 mm diameter. The suffix 'L' denotes larger contacts.

### PROTECTION

Optional barriers can be fitted into contact housings, except for SW190 and SW192, to protect against environmental dust etc.

Magnetic blowouts should not be used with closed contact housings.

### DC182 & DC184

The DC182 motor reversing contactors have a monoblock construction. They comprise two single pole changeover contactors configured in such a way so that all the necessary links for DC motor reversing applications are contained within the contact housing.

This results in a neat compact design which is compatible with modern electronic control systems.

The main terminals can be configured in a variety of ways in order to suit the application layout.

All the features described in this brochure for the other contactors in the SW180 range apply to the DC182.



Similarly all the optional extras listed apply:

- Magnetic blowouts (suffix B)
- Auxiliary contacts (suffix A)
- Large contact tips (suffix L)

A variety of methods for mounting the contactor are available:

- (1) An integral bracket.
- (2) Tapped holes in the contactor frame for direct panel mounting.
- (3) A separate bracket, part number 2155-165 for mounting the contactor at 90° to a panel.

The DC182 is physically and electrically interchangeable with the SW182 reversing contactor.

A paired single pole on/off contactor can also be supplied. This is the type DC184 and this contactor can also have integral links for the main poles if required.

### DC182

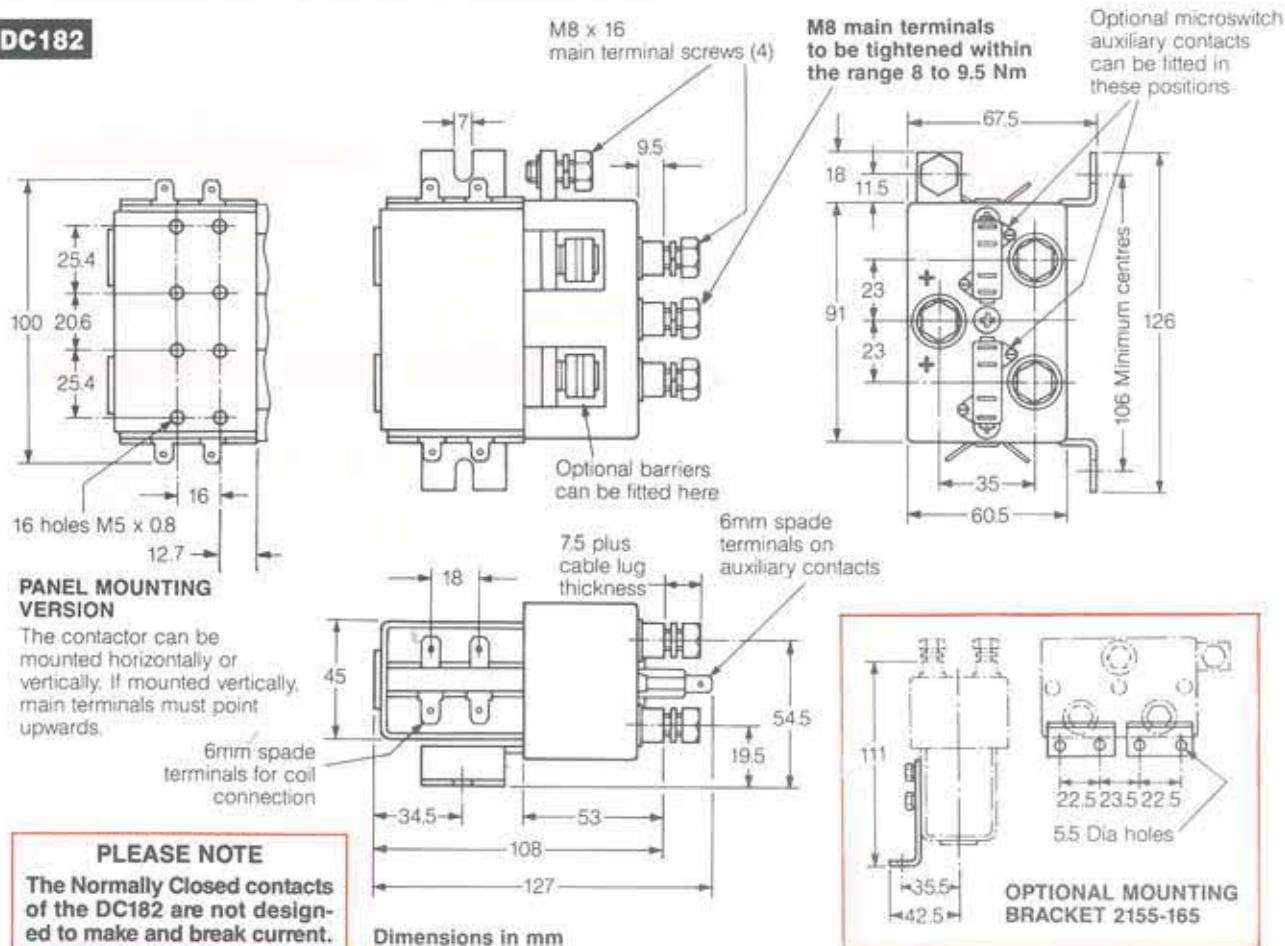

## CONNECTION DIAGRAMS

### SW180

Single Pole Single Throw (On/Off) Contactor



### SW181

Single Pole Double Throw (Changeover) Contactor



### SW185

Single Pole Single Throw (Off/On) Normally Closed Contactor



### SW182

Paired Single Pole Double Throw Contactor. Complete with necessary links for motor reversing

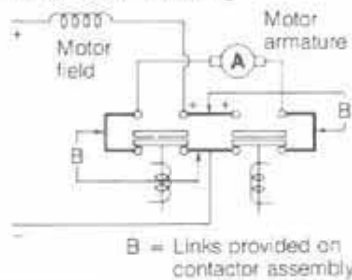

B = Links provided on contactor assembly

### SW192

Paired Double Pole Single Throw Contactor complete with links for motor reversing

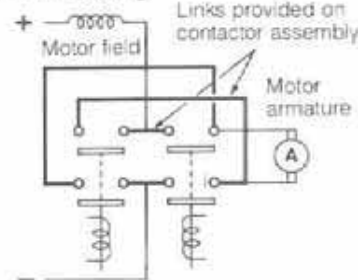

### SW190

Double Pole Single Throw Contactor



### DC182 AND DC184

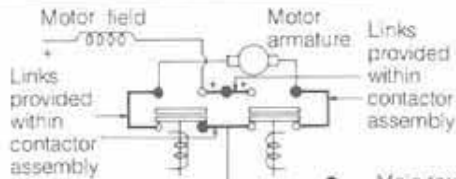

DC182

● = Main terminal

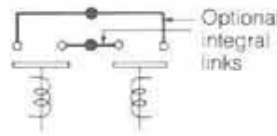

DC184



AUXILIARY CONTACTS

## CONTACTOR WEIGHTS

Add 20 gms for each auxiliary

Add 50 gms for each set of blowout magnets.

SW180	640 gms	SW182	1680 gms	SW185	655 gms	SW190	760 gms	DC182	1660 gms
SW181	780 gms	SW184	1350 gms	SW189	1380 gms	SW192	1660 gms	DC184	1450 gms

## EXPLANATION OF CONTACTOR TYPE NUMBERS

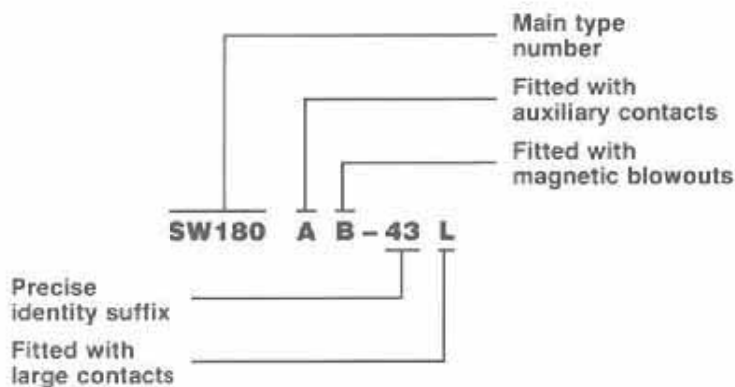

	Auxiliary Contacts	Magnetic Blowouts	Mounting Brackets	Large Contact Tips	Closed Contact Housing
SW180	O	O	O	O	O
SW181	O	O	O	O	O
SW182	O	O	S	O	O
SW184	O	O	S	O	O
SW185	O	O	O	O	O
SW189	O	O	S	O	O
SW190	O	O	O	O	N
SW192	N	O	S	O	N
DC182	O	O	S	O	O
DC184	O	O	S	O	O

O = Optional Extra S = Standard Feature N = Not Available

## COIL RESISTANCES FOR POPULAR VOLTAGES

	12V DC	24V DC	36V DC	48V DC	60V DC	72V DC	80V DC
Intermittently rated coils (ohms)	5	17	44	73	102	150	212
Continuously rated coils (ohms)	13	44	102	150	282	427	427

## PERFORMANCE DATA

Thermal current rating (100%) 150 Amperes

Intermittent current rating  
 30% duty 275 Amperes  
 40% duty 240 Amperes  
 50% duty 225 Amperes  
 60% duty 200 Amperes  
 70% duty 180 Amperes

Typical fault currents which can be ruptured (5ms time constant)  
 SW180 and SW185 1000 Amperes at 48V D.C.  
 SW180B and SW185B 1000 Amperes at 96V D.C.  
 SW181\*, SW182\* and DC182\* 1000 Amperes at 48V D.C.  
 SW181B\*, SW182B\* and DC182B\* 1000 Amperes at 96V D.C.  
 SW190 and SW192 1000 Amperes at 80V D.C.  
 SW190B and SW192B 600 Amperes at 120V D.C.

\* Normally open contacts, not normally closed contacts.

Maximum recommended contact voltages  
 SW180 and SW185 48V D.C.  
 SW180B and SW185B 96V D.C.  
 SW181, SW182 and DC182 48V D.C.  
 SW181B, SW182B and DC182B 96V D.C.  
 SW190 and SW192 96V D.C.  
 SW190B and SW192B 120V D.C.

Typical voltage drop across contacts per 100 Amperes  
 SW180 and SW185 30mV  
 SW190 and SW192 (per pole) 40mV  
 SW181, SW182 and DC182 (normally open contacts) 30mV  
 SW181, SW182 and DC182 (normally closed contacts) 40mV

Mechanical life > 5 x 10<sup>6</sup>

Coil power dissipation  
 Intermittently rated types 30-40 Watts  
 Continuously rated types 10-15 Watts

Maximum pull-in voltage (coil at 20°C)  
 Intermittently rated types 60%V  
 Continuously rated types 66%V

Typical drop-out voltage 10-20%V

Pull-in time approx (n/o contacts to close) 30ms

Drop-out time approx (n/o contacts to open)  
 Without suppression 8ms  
 With diode suppression 60ms  
 With diode and resistor (depending on value) 25ms

Main contact changeover time (SW181, SW182 and DC182)  
 Normally closed to normally open 12ms  
 Normally open to normally closed 5ms

Typical contact bounce period 3ms

Auxiliary contact thermal current rating 5 Amperes

Auxiliary contact switching capacities (resistive load)  
 5A at 24V D.C.  
 2A at 48V D.C.  
 0.5A at 240V D.C.

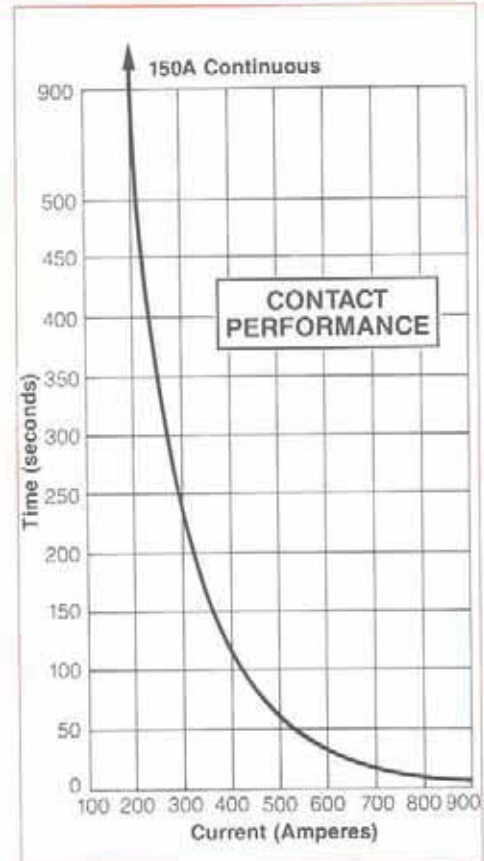

All the performance data figures should be used as a guide only. Alternative ratings may be considered according to applications.

Albright is registered under BS EN ISO 14001 - Environmental Management System. Should you require information on the disposal of our products, please contact our Health, Safety & Environmental Manager or your Local Supplier for our Disposal Guidance Note.



ALBRIGHT INTERNATIONAL LTD  
 Evingar Trading Estate, Ardglan Road, Whitchurch, Hampshire, RG26 7BB, UK, Tel: +44 (0)1256 893060, Fax: +44 (0)1256 893562  
 Dedicated Sales: Tel: +44 (0)1256 890030, Fax: +44 (0)1256 890043  
 Email: sales@albrightinternational.com or technical@albrightinternational.com  
 Web Site: www.albrightinternational.com