

Albright

SW100 Series of D.C. Contactors

SW100
On/Off Contactor

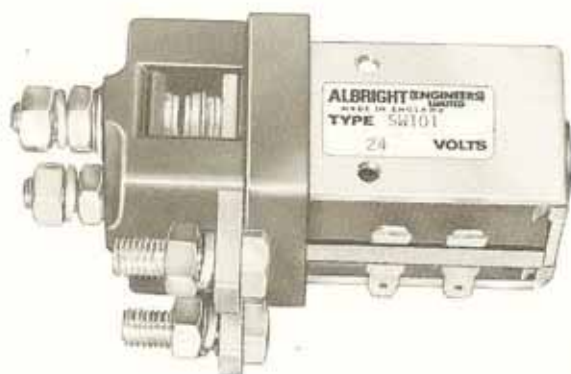
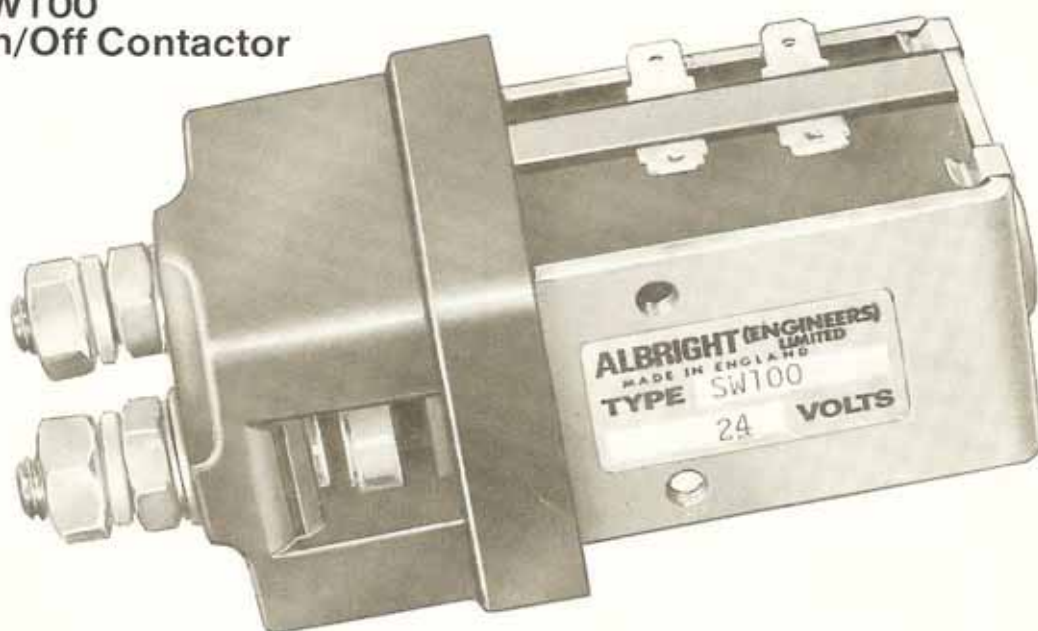

SW101
Changeover
Contactor

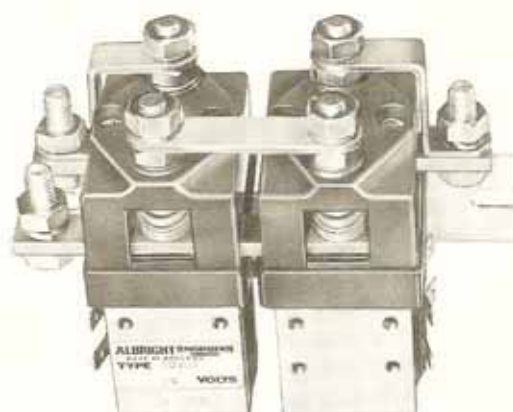

SW102
Paired Changeover
Contactor

SW 100 and SW 101

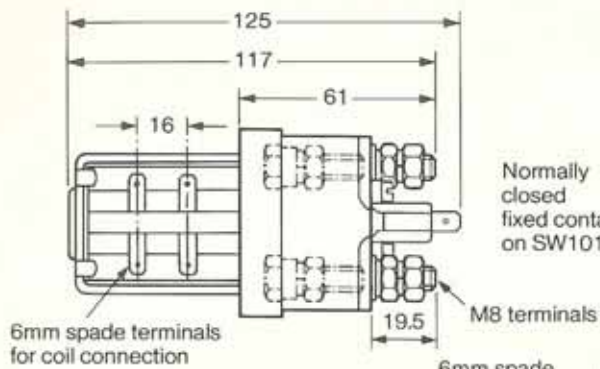

Normally closed fixed contacts on SW101

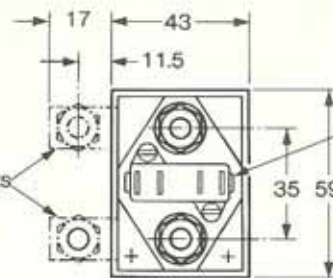

Optional microswitch auxiliary contact can be fitted here

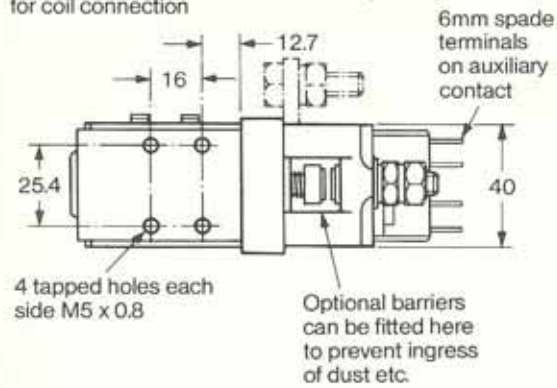

OPTIONAL MOUNTING BRACKETS

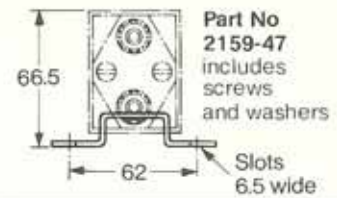
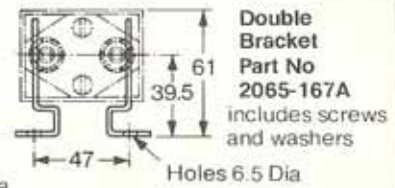
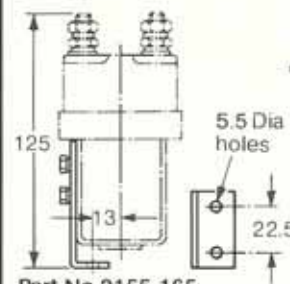

All dimensions in mm.

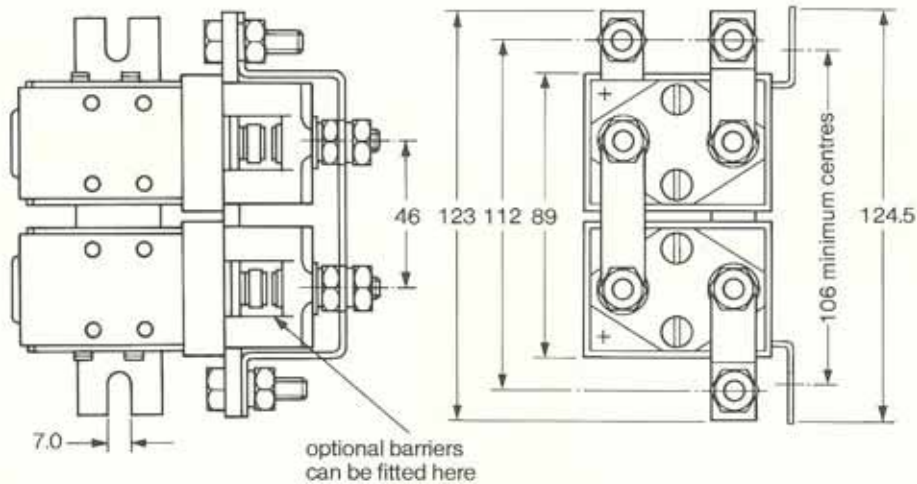

SW 102

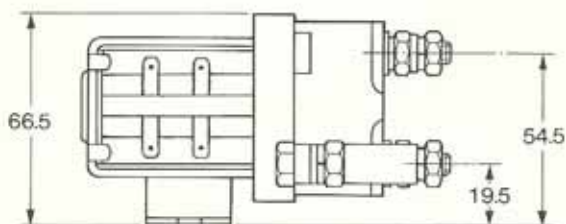

The paired contactors are fitted with mounting bracket as shown

Auxiliary contacts can be fitted as shown on SW100

The contactors can be mounted either horizontally or vertically. If mounted vertically contact studs must point upwards.

All dimensions in mm.

The SW100 series of contactors has been designed for direct current loads, particularly motors as used on electric vehicles.

The contactors by virtue of their double break, double magnetic blowout configurations are able to rupture direct currents at voltages up to at least 96. The design is such that contacts close with the minimum of bounce—a very important feature when switching currents with rapid rise times.

Alternating current can be switched by the SW100 and it is possible for barriers to be fitted into the contact apertures to prevent the ingress of dust etc. (Magnetic blowouts should not be specified in either of these two instances).

Contact material is silver cadmium oxide which is weld resistant, hard wearing and has excellent conductivity.

Coil connections are by means of 6 mm spades (two per terminal).

Coils are wound for direct current operation but if required for alternating current a rectifier can be fitted.

Mounting of the SW100 and SW101 types is by means of M5 threaded holes on the contactor frame. Alternatively mounting brackets (see drawing) can be supplied complete with screws.

The SW102 is supplied as a complete assembly with double mounting bracket.

Pull-in and drop out voltages are normally 60% and 10% of rated voltage respectively, but variations from these figures can be engineered to suit particular applications.

A double circuit normally open, normally closed micro switch auxiliary contact can be fitted and to denote this the suffix 'A' should be added to the type number e.g. SW100A.

Magnetic blowouts should be specified when voltages in excess of 48VDC are to be switched or if the load is highly inductive. To denote a contactor with blowouts add the suffix 'B' e.g. SW100B

CORRECT POLARITY OF MAIN TERMINALS MUST BE OBSERVED WHEN BLOWOUTS ARE FITTED.

The range comprises:—

SW100 Single Pole Single Throw (On/Off) Contactor

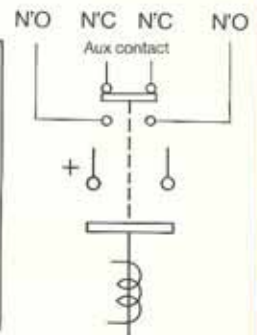
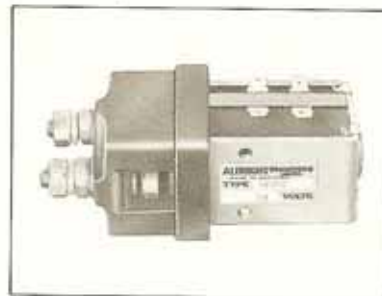

SW101 Single Pole Double Throw (Changeover) Contactor

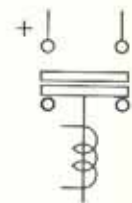
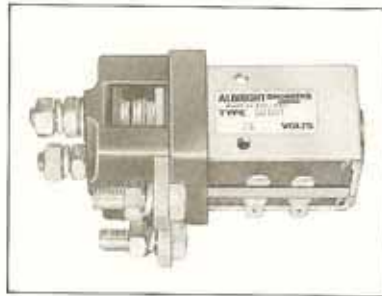

SW102 Paired Single Pole Double Throw Contactor. Complete with necessary links for motor reversing.

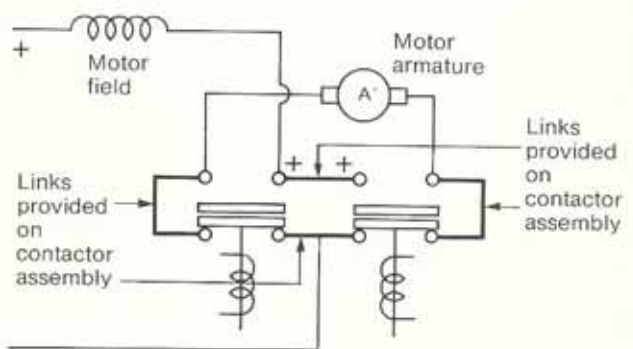

Performance Data

Max. thermal current rating (100%) 125 Amperes
 Max. intermittent current rating (50%) 180 Amperes
 Breaking current at time constant 5MS with blowouts, SW100B >1000 Amperes at 96 VDC
 Max d.c. voltage when blowouts not fitted 48VDC
 Typical voltage drop across terminals 30 mV per 100 Amperes
 Mechanical life > 3 x 10⁶ operations
 Typical coil power dissipation (50% rating) 15-25 watts
 Typical coil power dissipation (100% rating) 7-12 watts

The above figures should be used as a guide only. Some derating may be necessary according to exact type and application.

Completion of the following information will enable us to offer the most suitable Contactor for your application.

Type No.	SW100	SW101	SW102
Configuration	S.P.S.T.	S.P.D.T.	2 x S.P.D.T.
Coil voltage			
50% or 100% rating			
A.C. or D.C.			
Main contact rating	Amperes		
	Volts (A.C./D.C.)		
Application type of load			
If motor KW rating			
Auxiliary contacts			
Any other details			

ALBRIGHT (ENGINEERS) LIMITED
 125 RED LION ROAD, TOLWORTH, SURBITON, SURREY KT6 7QS, ENGLAND
 TELEPHONE: 01-390 5357. TELEFAX: 01-390 1927. TELEX: 928588