

| Application   | Interrupted | Uninterrupted               |
|---|-------------|-----------------------------|
| Thermal Current Rating ( <sup>th</sup> )  | ▶           | 150A                        |
| Intermittent Current Rating:  |             |                             |
| 30% Duty  | ▶           | 275A                        |
| 40% Duty  | ▶           | 235A                        |
| 50% Duty  | ▶           | 210A                        |
| 60% Duty  | ▶           | 195A                        |
| 70% Duty  | ▶           | 180A                        |
| Rated Fault Current Breaking Capacity ( <sup>cn</sup> ) 5ms Time Constant:<br>(in accordance with UL583*) |             |                             |
| DC182   | ▶           | 1000A at 48V                |
| DC182B  | ▶           | 1000A at 96V                |
| Maximum Recommended Contact Voltages (U <sub>0</sub> ):   |             |                             |
| DC182   | ▶           | 48V D.C.                    |
| DC182B  | ▶           | 96V D.C.                    |
| Typical Voltage Drop per pole across New Contacts at 150A:  |             |                             |
| Normally Open   | ▶           | 30mV                        |
| Normally Closed   | ▶           | 40mV                        |
| Mechanical Durability   | ▶           | >5 x 10 <sup>6</sup> Cycles |
| Coil Voltage Available (U <sub>0</sub> )<br>(Rectifier board required for A.C.)                           |             | From 6 to 240V D.C.         |
| Coil Power Dissipation:   |             |                             |
| Highly Intermittent Rated Types   | ▶           | 40 - 50 Watts               |
| Intermittently Rated types  | ▶           | 30 - 40 Watts               |
| Prolonged Rated Types   | ▶           | 15 - 30 Watts               |
| Continuously Rated Types  | ▶           | 10 - 15 Watts               |
| Maximum Pull-In Voltage (Coil at 20° C) Guideline:  |             |                             |
| Highly Intermittent Rated types<br>(Max 25% Duty Cycle)   | ▶           | 60% U <sub>s</sub>          |
| Intermittently Rated types<br>(Max 70% Duty Cycle)  | ▶           | 60% U <sub>s</sub>          |
| Prolonged Operation<br>(Max 90% Duty Cycle)   | ▶           | 60% U <sub>s</sub>          |
| Continuously Rated Types<br>(100% Duty Cycle)   | ▶           | 66% U <sub>s</sub>          |
| Drop-Out Voltage Range  | ▶           | 10 - 25% U <sub>s</sub>     |
| Typical Pull-In Time  | ▶           | 30ms                        |
| Typical Drop-Out Time (N/O Contacts to Open):   |             |                             |
| Without Suppression   | ▶           | 8ms                         |
| With Diode Suppression  | ▶           | 60ms                        |
| With Diode and Resistor<br>(Subject to resistance value)  | ▶           | 25ms                        |
| Typical Main Contact Changeover Time (milliseconds):  |             |                             |
| Normally Closed to Normally Open  | ▶           | 12ms                        |
| Normally Open to Normally Closed  | ▶           | 5ms                         |
| Typical Contact Bounce Period   | ▶           | 3ms                         |
| Operating Ambient Temperature   | ▶           | - 40°C to + 60°C            |
| Guideline Contactor Weight:   |             |                             |
| DC182   | ▶           | 1660 gms                    |
| Per Auxiliary   | ▶           | + 40 gms                    |
| With Blowouts   | ▶           | + 75 gms                    |

| Auxiliary Details  |                     |
|--|---------------------|
| Auxiliary Thermal Current Rating                           | ▶ 5A                |
| Auxiliary Contact Switching Capabilities (Resistive Load): |                     |
|  | ▶ 5A at 24V D.C.    |
|  | ▶ 2A at 48V D.C.    |
|  | ▶ 0.5A at 240V D.C. |

Connection Conductor Sizes for Maximum Continuous Current Should be Rated Suitable for Application

**Key:** ▶ = Interrupted ▲ = Uninterrupted

**Note:** Where applicable values shown are at 20° C

- \* Please check our web site for product UL status
- Performance data provided should be used as a guide only. Some de-rating/variation from figures may be necessary according to application.
  - Thermal current ratings stated are dependant upon size of conductor used
  - For further technical advice email: [technical@albrightinternational.com](mailto:technical@albrightinternational.com)
  - Albright reserve the right to change data without prior notice

The DC182 motor reversing type of contactor has been designed for direct current loads, particularly motors as used on electric vehicles such as industrial trucks. The DC182 is a monoblock construction, resulting in a compact design which is compatible with modern electronic control systems. Developed for both interrupted and uninterrupted loads, the DC182 is suitable for switching Resistive, Capacitive and Inductive loads.

- Interrupted current - opening and closing on load with frequent switching (results in increased contact resistance).
- Uninterrupted current - no or infrequent load switching requirements (maintains a lower contact resistance).

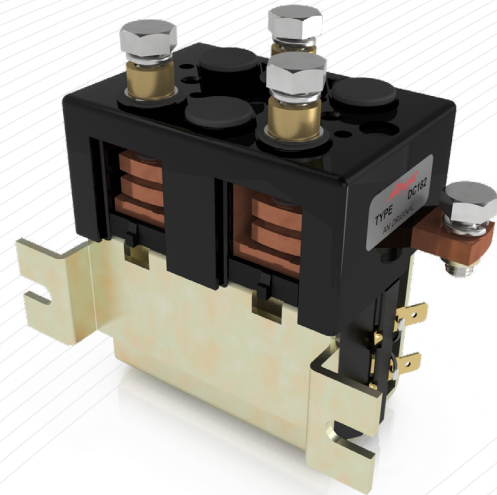

DC182 (with integral bracket)

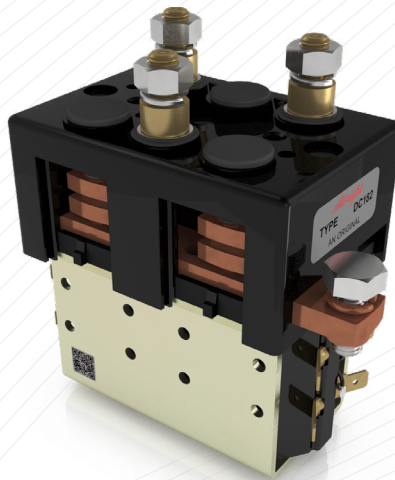

DC182 (with optional tapped holes)

The main contact circuit, designed for motor reversing, has a built in failsafe, so that if both coils are energised simultaneously the contact arrangement is open circuit. The DC182 has double breaking main contacts with silver alloy contact tips, which are weld resistant, hard wearing and have excellent conductivity. The DC182 M8 main stud terminals can be configured in a variety of ways in order to suit the application. Coil connections are by means of 6.3mm spades and mounting is via the supplied bracket and can be horizontal or vertical, when vertical the M8 contact studs should point upwards. If the requirement is for downwards orientation we can adjust the contactor to compensate for this.

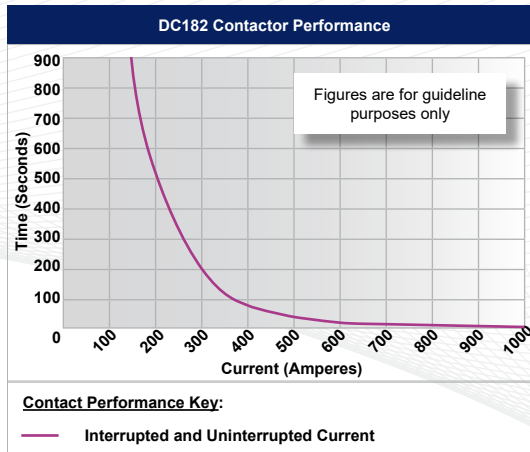

**Contact Performance Key:**  
— Interrupted and Uninterrupted Current

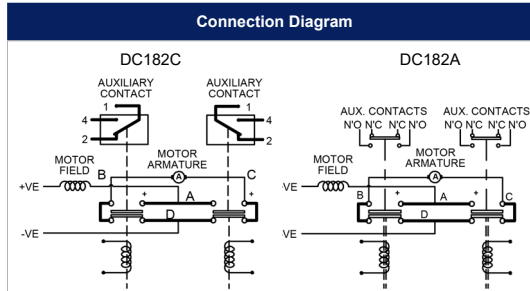

| DC182 Available Options                           |   |        |
|---|---|--------|
| General   |   | Suffix |
| Auxiliary Contacts                                | ○ | A      |
| Auxiliary Contacts - V3                           | ○ | C      |
| Magnetic Blowouts†                                | ○ | B      |
| Magnetic Blowouts - High Powered†                 | X |        |
| Armature Cap                                      | ● |        |
| Mounting Brackets<br>(See overleaf)               | ● |        |
| Magnetic Latching† (Not fail safe)                | ○ | M      |
| Dust Shields†                                     | ○ |        |
| Environmentally Protected IP66                    | X |        |
| EE Type (Steel Shroud)                            | ○ | EE     |
| Contacts  |   |        |
| Large Tips  | ○ | L      |
| Textured Tips                                     | ○ | T      |
| Silver Plating                                    | X |        |
| Coil  |   |        |
| AC Rectifier Board (Fitted)                       | ○ |        |
| Coil Suppression†                                 | ○ |        |
| Flying Leads                                      | ○ | F      |
| Manual Override Operation                         | X |        |
| M4 Stud Terminals                                 | X |        |
| M5 Terminal Board                                 | ○ |        |
| Vacuum Impregnation                               | ○ |        |
| <b>Key:</b> Optional ○ Standard ● Not Available X |   |        |
| † Connections become polarity sensitive           |   |        |
| ‡ Open Housing Available                          |   |        |

**Top Cover Configurations**

**Normally Closed Contact**

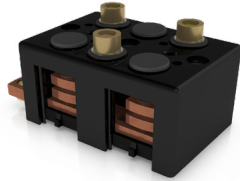

Standard

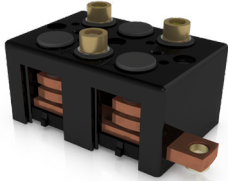

Alternative

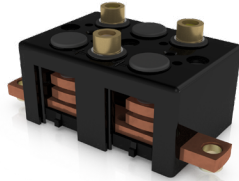

Double Ended

**Polarity Orientation**

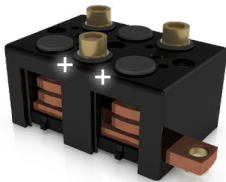

+ Forward

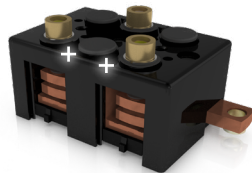

+ Reversed

**Main Terminal Options and Mounting Options**



Stud Male Post



Female Post <sup>1</sup>

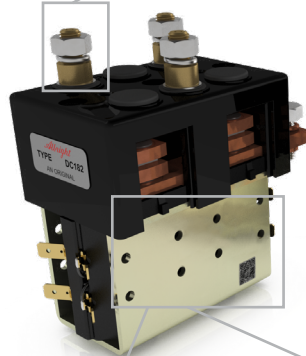

M5 Tapped Holes

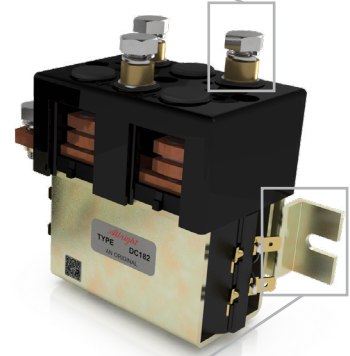

L Bracket <sup>2</sup>

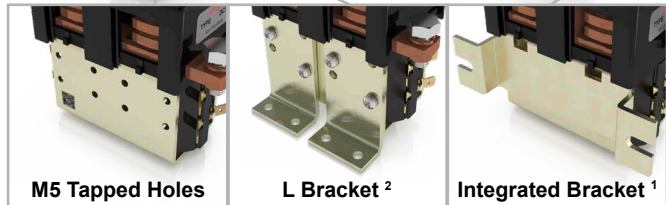

Integrated Bracket <sup>1</sup>

<sup>1</sup> Fitted as Standard <sup>2</sup> See Stud Range Catalogue for Details

**PANEL MOUNTING VERSION**

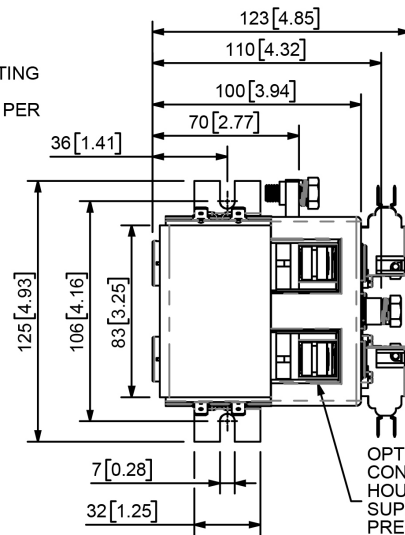
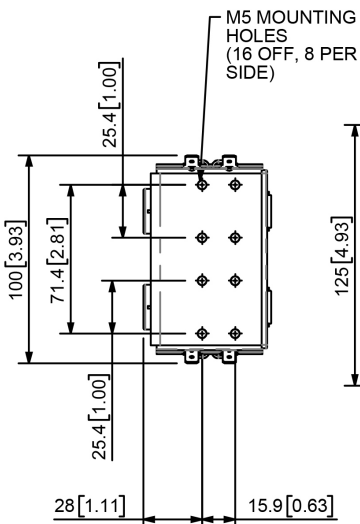

OPTIONAL MICROSWITCH AUXILIARY CONTACT WITH 6.3mm [0.25] SPADE TERMINALS CAN BE FITTED HERE

NORMALLY CLOSED CONTACT

OPTIONAL CLOSED CONTACT HOUSING CAN BE SUPPLIED TO PREVENT INGRESS OF DUST ETC.

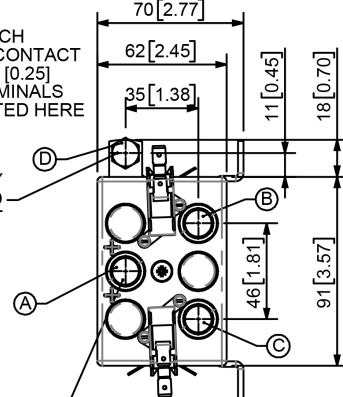

M8 MAIN TERMINALS TO BE TIGHTENED WITHIN RANGE 8 - 9.5Nm

6.3mm [0.25] SPADE TERMINALS FOR COIL CONNECTIONS

**DC182A (Auxiliary Contacts)**

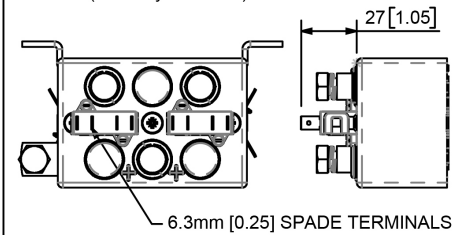

Dimensions in mm [inches]