

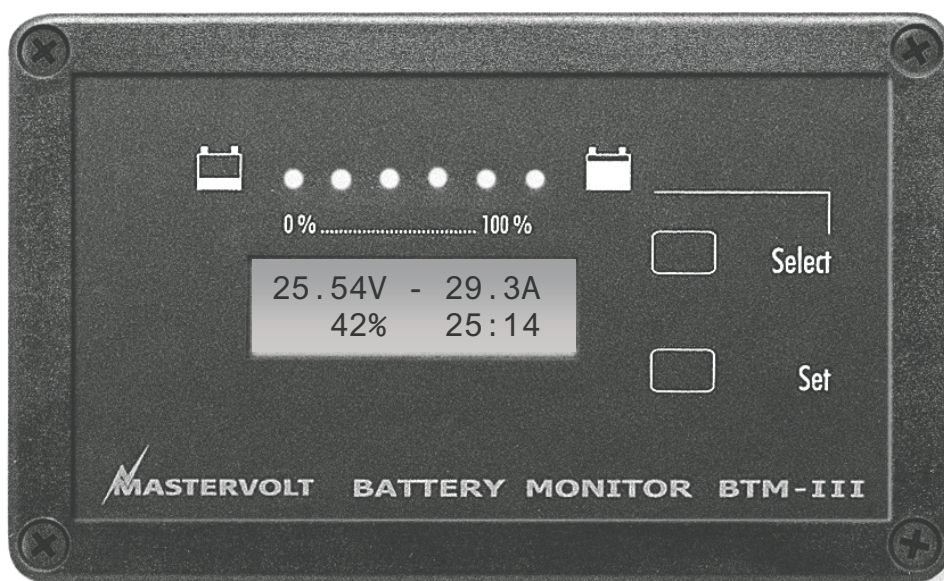

USERS MANUAL / GEBRUIKERSHANDLEIDING / BETRIEBSANLEITUNG  
MANUEL D'UTILISATION / MANUAL DE UTILIZACION

# Masterlink BTM III

Monitor for three independent battery sets



MASTERVOLT  
Snijdersbergweg 93,  
1105 AN Amsterdam  
The Netherlands  
Tel.: +31-20-3422100  
Fax.: +31-20-6971006  
www.mastervolt.com

ENGLISH:	PAGE 1
NEDERLANDS:	PAGINA 37
DEUTSCH:	SEITE 73
FRANÇAIS:	PAGINA 109
CASTELLANO:	PÁGINA 145

v 4.2 November 2006

## QUICK REVIEW

The **Masterlink BTM-III** is the “fuel gauge” for up to three battery banks

The **LED bar** shows how full the main battery set is (bank 1): each LED represents 16%.

This **green LED** indicates that the main batteries are full (96-100%).  
(chapter 11.4)

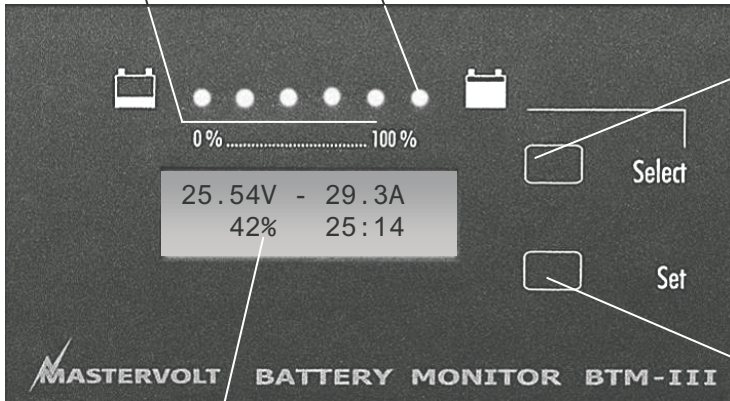

Touch **Select** shortly to scroll through the menu  
If you hold **Select** pressed for approximately 3 seconds, several advanced **Submenus** can be entered (chapter 7)

Use **Set** for adjustment of settings

The **Main menu** (chapter 6) provides a quick status overview of your batteries:

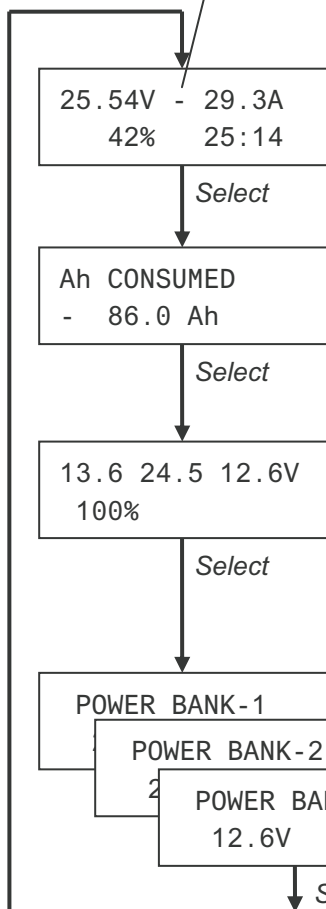

This screen is displayed by default.  
It shows the voltage (Volt), current (Amps), state of charge (%) and time-to-go (hrs:min) of the main battery (battery bank 1)

Press **Select** shortly. The next screen shows the actual capacity consumed from the main battery (battery bank 1)

Press **Select** again for a quick status overview of all battery banks simultaneously.  
It shows the Battery voltages of each battery and the State Of Charge (SOC)

Press **Select** several times to show the actual voltage and State of Charge of each battery bank

NOTE: Displayed data may differ.

**CONTENTS:**

v 4.2 November 2006

<b>QUICK REVIEW .....</b>	<b>2</b>
<b>1 GENERAL INFORMATION.....</b>	<b>6</b>
1.1 Use of this manual .....	6
1.2 Guarantee specifications .....	6
1.3 Quality.....	6
1.4 Validity of this manual.....	6
1.5 Liability.....	6
1.6 Changes to the Masterlink BTM III .....	6
<b>2 SAFETY GUIDELINES AND MEASURES.....</b>	<b>7</b>
2.1 Warnings and symbols .....	7
2.2 Use for intended purpose .....	7
2.3 Organizational measures.....	7
2.4 Maintenance and repair.....	7
2.5 General safety and installation precautions .....	7
2.6 Warning regarding the use of batteries. ....	7
<b>3 OPERATION .....</b>	<b>8</b>
3.1 Introduction .....	8
3.2 Monitoring of three battery sets .....	8
3.3 Features.....	8
3.4 Software.....	8
3.5 LCD display .....	9
3.6 LED-bar .....	9
3.7 Set/Select-buttons .....	9
3.8 Alarm function.....	9
3.9 Submenus.....	9
<b>4 INSTALLATION .....</b>	<b>10</b>
4.1 Things you need for installation.....	10
4.2 Installation step by step .....	10
<b>5 FIRST START-UP .....</b>	<b>13</b>
5.1 Language setting .....	13
5.2 Synchronisation .....	13
5.2.1 Adjustment of values .....	13
5.2.2 Settings for battery bank 1 (Service battery).....	14
5.2.3 Settings for battery bank 2 and 3 .....	15
<b>6 MAIN MENU.....</b>	<b>16</b>
6.1 Initial level .....	16
6.2 Consumed Amphours .....	16
6.3 Short menu (Voltage and SOC).....	16
6.4 Long menu (Source name and values) .....	16
<b>7 NAVIGATION THROUGH THE SUBMENUS.....</b>	<b>17</b>

<b>8</b>	<b>HISTORICAL DATA MENU .....</b>	<b>18</b>
8.1	Time since start-up .....	18
8.2	Time since last low battery alarm .....	18
8.3	Time since last full charge .....	18
8.4	Cycles count .....	18
8.5	Abuse cycles.....	18
8.6	Discharged time.....	19
8.7	Calculated value for the CEF.....	19
8.8	Total Ampere hours consumed .....	19
8.9	Average discharge battery bank 1.....	19
8.10	Deepest discharge battery bank 1.....	19
8.11	Highest voltage battery bank 1 .....	19
8.12	Deepest discharge battery bank 2.....	20
8.13	Highest voltage battery bank 2 .....	20
8.14	Deepest discharge battery bank 3.....	20
8.15	Highest voltage battery bank 3 .....	20
8.16	Exit level .....	20
<b>9</b>	<b>BATTERY BANK MENUS 1, 2 AND 3 .....</b>	<b>21</b>
9.1	Battery bank name.....	21
9.2	Nominal battery voltage .....	21
9.3	Battery capacity .....	21
9.4	Nominal charger current .....	21
9.5	Average discharge amps .....	22
9.6	Alarm function on/off.....	22
9.7	Low voltage setpoint .....	22
9.8	High voltage setpoint .....	22
9.9	Alarm delay time .....	22
9.10	State of Charge level for "empty battery".....	22
9.11	State of Charge level for "full battery" .....	23
9.12	Minimum runtime alarm function .....	23
9.13	Maximum runtime alarm function .....	23
9.14	Exit level .....	23

<b>10</b>	<b>SETTINGS MENU .....</b>	<b>24</b>
10.1	Lock mode .....	24
10.2	Language .....	24
10.3	Energy save mode .....	24
10.4	Charge Efficiency Factor battery Bank 1 .....	24
10.5	Peukert Exponent battery bank 1 .....	25
10.6	Reset historical data battery bank 1 .....	25
10.7	Charge amps for full battery .....	25
10.8	Float voltage .....	25
10.9	Battery bank 1: No shunt .....	26
10.10	Charge Efficiency Factor battery Bank 2 .....	26
10.11	Peukert Exponent battery bank 2 .....	26
10.12	Reset historical data battery bank 2 .....	26
10.13	Charge Efficiency Factor battery Bank 3 .....	26
10.14	Peukert Exponent battery bank 3 .....	26
10.15	Reset historical data battery bank 3 .....	26
10.16	Visualisation of SOC for battery bank 2 + 3 .....	26
10.17	Reset to Factory Settings .....	27
10.18	Software version .....	27
10.19	NMAE out: On/Off .....	27
10.20	Exit level .....	27
<b>11</b>	<b>ADDITIONAL INFORMATION .....</b>	<b>28</b>
11.1	BATTERY ALARM FUNCTION .....	28
11.2	Charge Efficiency Factor (C.E.F.) .....	28
11.3	Peukert exponent .....	29
11.4	State of charge .....	29
11.5	Replacement of batteries .....	29
11.6	MasterAdjust software .....	30
11.7	Peukert Calculator .....	30
11.8	Battery names .....	31
11.9	NMEA0183 format .....	31
11.10	Ordering information .....	31
<b>12</b>	<b>TROUBLE SHOOTING .....</b>	<b>32</b>
<b>13</b>	<b>SPECIFICATIONS .....</b>	<b>34</b>
13.1	Technical specifications .....	34
13.2	Dimensions .....	35
<b>14</b>	<b>EC DECLARATION OF CONFIRMITY .....</b>	<b>36</b>

# 1 GENERAL INFORMATION

## 1.1 USE OF THIS MANUAL

This manual serves as a guideline for the safe and effective operation, maintenance and possible correction of minor malfunctions of the *Masterlink BTM III*.

This manual is valid for the following models:

Description	Part number
Masterlink BTM III	70403163

It is therefore obligatory that every person who works on or with the *Masterlink BTM III* must be completely familiar with the contents of this manual, and that he/she carefully follows the instructions contained herein.

Installation of, and work on the *Masterlink BTM III*, may be carried out only by qualified, authorised and trained personnel, consistent with the locally applicable standards and taking into consideration the safety guidelines and measures (chapter 2 of this manual).

Keep this manual at a secure place!

The English version has 36 pages.

## 1.2 GUARANTEE SPECIFICATIONS

Mastervolt guarantees that this unit has been built according to the legally applicable standards and specifications. Should work take place, which is not in accordance with the guidelines, instructions and specifications contained in this users manual, then damage may occur and/or the unit may not fulfil its specifications. All of these matters may mean that the guarantee becomes invalid.



### CAREFUL!

Additional warranty agreements, like "Mastervolt system warranty" may contain restrictions which forbid resetting of historical data, as described in chapter 10.

## 1.3 QUALITY

During their production and prior to their delivery, all of our units are exhaustively tested and inspected. The standard guarantee period is two years.

## 1.4 VALIDITY OF THIS MANUAL

All of the specifications, provisions and instructions contained in this manual apply solely to standard versions of the *Masterlink BTM III* delivered by Mastervolt.

## 1.5 LIABILITY

Mastervolt can accept no liability for:

- consequential damage due to use of the *Masterlink BTM III*;
- possible errors in the manuals and the results thereof.



### CAREFUL!

Never remove the type number plate.

Important technical information required for service, maintenance & secondary delivery of parts can be derived from the type number plate.

## 1.6 CHANGES TO THE MASTERLINK BTM III

Changes to the *Masterlink BTM III* may be carried out only after obtaining the written permission of Mastervolt.

## 2 SAFETY GUIDELINES AND MEASURES

### 2.1 WARNINGS AND SYMBOLS

Safety instructions and warnings are marked in this manual by the following pictograms:



#### CAREFUL!

Special data, restrictions and rules with regard to preventing damage.



#### WARNING

A WARNING refers to possible injury to the user or significant material damage to the charger if the user does not (carefully) follow the procedures.

### 2.2 USE FOR INTENDED PURPOSE

- 1 The *Masterlink BTM III* is constructed as per the applicable safety-technical guidelines.
- 2 Use the *Masterlink BTM III* only:
  - in a technical correct condition;
  - in a closed, well-ventilated room, protected against rain, moist, dust and condensation;
  - observing the instructions in the users manual.



#### WARNING

Never use the *Masterlink BTM III* in locations where there is danger of gas or dust explosion or potentially flammable products!

- 3 Use of the *Masterlink BTM III* other than mentioned in point 2 is not considered to be consistent with the intended purpose. Mastervolt is not liable for any damage resulting from the above.

### 2.3 ORGANIZATIONAL MEASURES

The user must always:

- have access to the user's manual;

- be familiar with the contents of this manual. This applies in particular to chapter 2, Safety Guidelines and Measures.

### 2.4 MAINTENANCE AND REPAIR

- 1 If the electrical installation is switched off during maintenance and/or repair activities, it should be secured against unexpected and unintentional switching on:
  - switch off all charging systems;
  - switch off the connection with the batteries or remove the DC fuse(s);
  - be sure that third parties cannot reverse the measures taken.
- 2 If maintenance and repairs are required, use only original spare parts.

### 2.5 GENERAL SAFETY AND INSTALLATION PRECAUTIONS

- Secure the DC wiring with a fuse, according to the guidelines in this manual.
- Connection and protection must be done in accordance with local standards.
- Do not work on the *Masterlink BTM III* or system if it is still connected to a current source. Only allow changes in your electrical system to be carried out by qualified electricians.
- Check the wiring at least once a year. Defects such as loose connections, burned cables etc. must be corrected immediately.

### 2.6 WARNING REGARDING THE USE OF BATTERIES.

Excessive battery discharge and/or high charging voltages can cause serious damage to batteries. Do not exceed the recommended limits of discharge level of your batteries. Avoid short circuiting batteries, as this may result in explosion and fire hazard. Installation of the batteries and adjustments of the *Masterlink BTM III* should only be undertaken by authorised personnel!

### 3 OPERATION

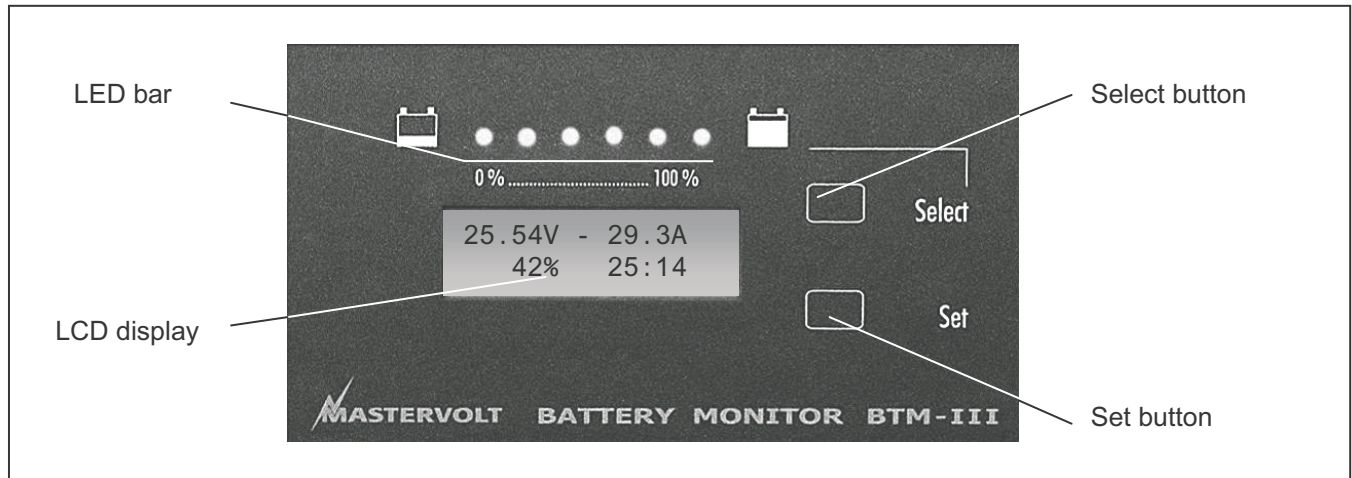

Figure 1: operation of the Masterlink BTM-III

#### 3.1 INTRODUCTION

The Mastervolt *Masterlink BTM-III* provides extended information about the status of your batteries. This information includes reading voltage, current, Ah, time remaining and remaining capacity in percentage terms of three independent battery banks. The *Masterlink BTM-III* has LED indicators for remote monitoring of the battery level. The LCD screen also displays direct online data or historical information. In a single screen the state of charge and the voltage of three battery banks can be shown simultaneously. The information on the display is available in ten languages: English, French, German, Spanish, Italian, Dutch, Norwegian, Danish, Swedish and Finnish.

#### 3.2 MONITORING OF THREE BATTERY SETS

The *Masterlink BTM-III* can monitor up to three battery banks. Battery bank 1 is monitored in the most accurate way, i.e. by measuring the (dis)charge current by means of a shunt. This will result in a very precise reproduction of the state of charge.

The status of battery bank 2 and 3 can not be measured by means of a shunt. If visualisation of the State Of Charge (SOC) is enabled, the status of battery bank 2 and 3 can be calculated by means of a complicated algorithm. Compared to battery bank 1 this method is less accurate, giving you a rough estimation only

In a system with only two battery banks the input of the third bank can be used as a backlight input. If you connect this with the navigational lights, for example, both will turn on simultaneously.

#### 3.3 FEATURES

- Monitoring of three independent battery banks (12/24V DC)
- Easy installation
- Shunt (precise measuring of battery bank 1)
- State of charge
- Automatic calculation of Charge Efficiency Factor (battery bank 1)
- Extensive historical data
- Including 'abuse counter' (indicating too deep and very slow discharges)
- Standard delivery includes grey installation housing and shunt 500A/50mV
- NMEA 0183 connection
- Read-out possible in ten different languages

#### 3.4 SOFTWARE

A software package (MasterAdjust) can be downloaded from the website to monitor and log all information onto a PC. The PC is connected via an optional MasterBus PC Link. The NMEA output can also be connected to a PC with this optional MasterBus PC Link. It is now easy to integrate energy monitoring into any software package. Please consult chapter 11 for the software, the PC Link and the twisted pair connection cable.



## 3.5 LCD DISPLAY

25.54V - 29.3A
42% 25:14

Figure 2: initial menu

The actual status and user specific information of the three battery banks is displayed at the *LCD display*. In its default mode the *initial menu* is shown, giving you a brief overview of the status of battery bank 1. See figure 2:

- Left hand top corner: Voltage at the terminals (V).
- Right hand top corner: Current (Amps) flowing in or out the battery. A negative value means that the battery is being discharged.
- Left-hand lower corner: State Of Charge (SOC) in %. This readout shows the actual amount of energy left in the battery. This percentage is also displayed by means of the LED bar.
- The remaining time before the battery will be empty (right hand lower corner). Maximum reading during a discharge: 480 Hours (> 20 days). During charging it shows “--:--”.

From the *initial menu* you can scroll through the *main menu* by touching the *Select button* shortly. The functions of the *main menu* are described in chapter 6.

## 3.6 LED-BAR

The LED bar shows the approximate state of charge of battery bank 1. Each LED represents 16 % of the battery capacity, with the last LED turning on when the battery is charged and ready to be used (96-100%).

If the battery is being discharged, the number of illuminating LED's will be decreased. If the battery is charged after a discharge, the number of illuminating LED's will be increased depending on the state of charge of the battery. If the battery is charged for 96-100 % last green LED will be lit indicating the battery is ready for a new cycle.

## 3.7 SET/SELECT-BUTTONS

The *Masterlink BTM-III* offers several menus to adjust settings. Navigation through these menus and the adjustment of parameters is done by means of the *Select-* and *Set-* button.

There is a distinction between pressing the *Select-* and *Set-* button for a short and a long time:

- *Select* (short). In general, when pressed shortly (less than 3 sec.), you can scroll through the (sub-) menus.
- *Set* (short). Depending on the shown data, when you press the *Set-*button shortly (less than 3 sec.), you can:
  - Enter a displayed submenu
  - Leave a (sub-)menu at the *Exit Menu*;
  - Adjust a value
- *Select* (long). Pressing the *Select* button for at least three seconds has two functions:
  - From the *main menu*, you can enter the submenus (see chapter 7);
  - You can change the direction of the arrow in the right part of the display when a value needs to be adjusted. If the arrow is pointing downwards (↓) the value can be decreased. If the arrow is pointing upwards (↑) the value can be increased.

*Set* (long). At certain submenus specific counters or historical data can be reset by holding the *Set* button pressed for at least three seconds

## 3.8 ALARM FUNCTION

If the State of Charge of the batteries is too low, or the battery voltage is either too high or too low, the battery alarm function can be activated. If activated, an external relay can be switched. See chapter 11.1 for additional information about the battery alarm function

## 3.9 SUBMENU

When you hold the *Select button* pressed for approximately 3 seconds, several submenus can be accessed for read-out of historical data or configuration functions. See chapter 7

## 4 INSTALLATION



### WARNING

During installation and commissioning of the *Masterlink BTM III*, the Safety Guidelines and Measures are applicable at all times. See chapter 2 of this manual.



### CAREFUL!

Wrong connections may cause damage to the *Masterlink BTM III* which is not covered by guarantee!

### 4.1 THINGS YOU NEED FOR INSTALLATION

Tools:

- A saw to make a cut-out in the instrument panel
- A 6mm drill to make a hole in the back of the installation housing.
- A wire cutter / stripper
- A crimping tool for cable terminals
- A cross-head screw driver
- 2 mm and 5 mm flat blade screwdrivers.

A complete set of spanners, pliers and wrenches may be helpful during the installation of the *Masterlink BTM III*

Materials:

- The *Masterlink BTM-III* panel (included)
- Grey installation housing (included)
- A 500Amp/50mV shunt (included). This shunt will only be applied for the current measurement of battery set 1. Current measurement for battery set 2 and 3 is not possible. For higher nominal currents a shunt up to 1000A/100mV may be applied instead (not included, see ordering information)
- 2x0.25mm<sup>2</sup> twisted pair wire, long enough to reach from the shunt to the *Masterlink BTM-III* panel
- Wires 0.25mm<sup>2</sup> for voltage sensing of each battery set and for the DC power supply of the *Masterlink BTM-III* panel
- Fuse holders with 2 A-T fuses to be integrated in the voltage sensing line to each battery set.
- As short as possible heavy duty battery cable, finished with cable lugs, to run from the minus pole of the battery to the shunt. Cable thickness must be in accordance with the electrical installation
- Option: an external alarm relay. Specifications: max current consumption: 100mA, Nominal voltage: same as the DC power supply.

### 4.2 INSTALLATION STEP BY STEP

1



Disconnect the electrical power:

- Switch off all consumers,
- Switch off all charging systems.
- Remove all battery fuses.
- Check with a suitable voltmeter whether the entire DC installation is voltage free.

2

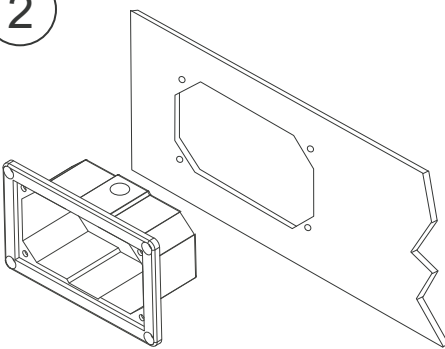

Mounting of the panel

The *Masterlink BTM III* panel should be placed as close as possible to the batteries. Maximum distance: 25 meters.

- Make a cut out in the instrument panel using the outline drawings of chapter 13 or using the mounting template of the box in which the *Masterlink BTM III* was delivered. Do not use the grey installation housing if you want to integrate the *Masterlink BTM III* in your Mastervision panel. For good visibility avoid installing the panel in direct sunlight
- Drill a hole in the back of the grey installation housing, on the side where it is easy to enter the cables

10

November 2006 / *Masterlink BTM-III* / EN

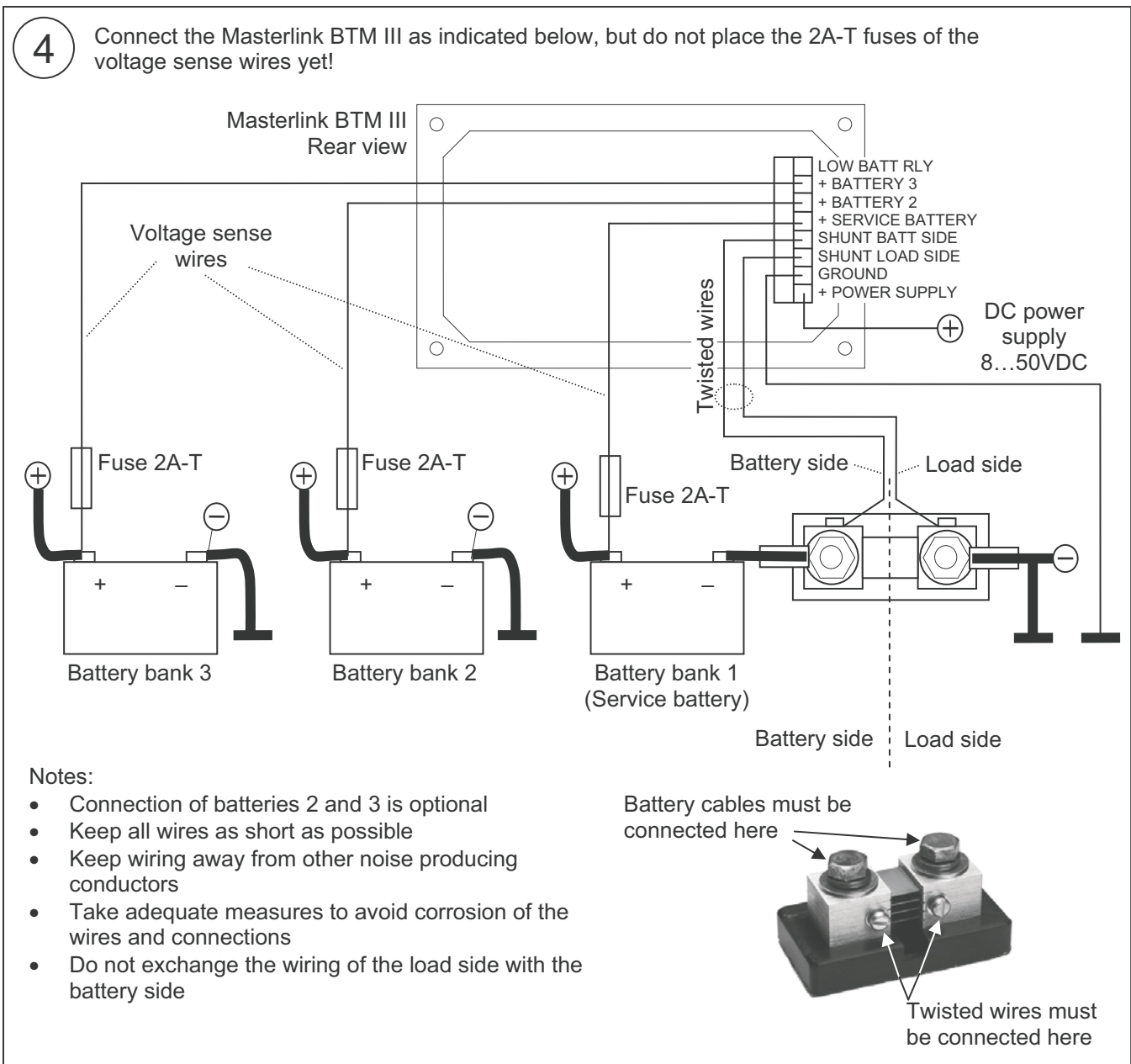
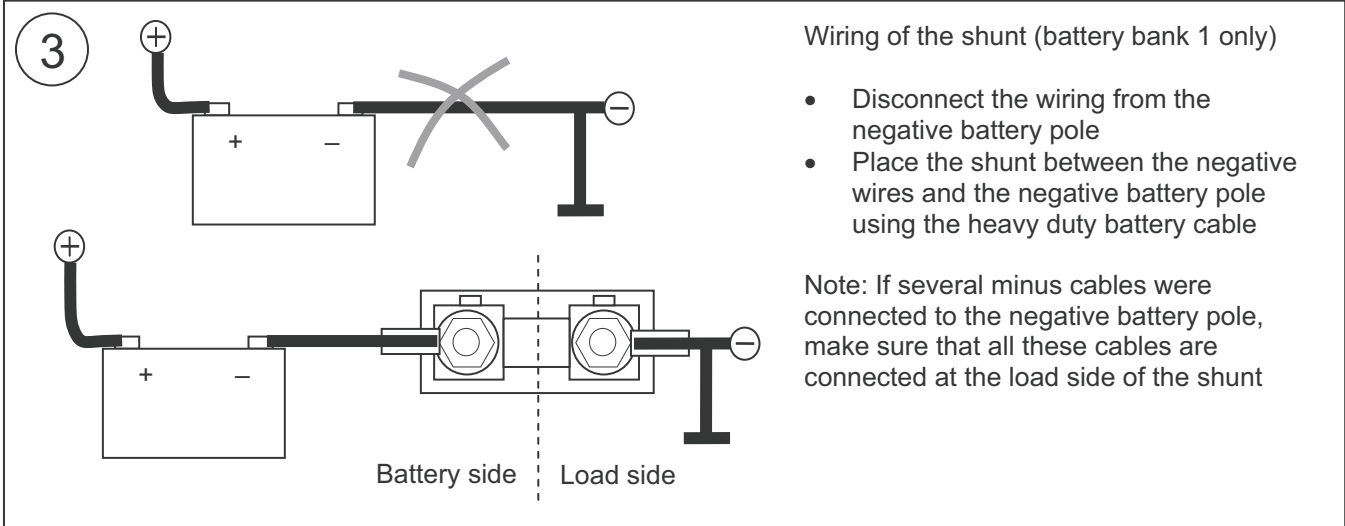

5

Options:

Option: Instead of connecting a battery, the DC-input for battery bank 3 can be also be connected to the control circuit of the dashboard lightning (3-35V). Then the backlight of the Masterlink BTM-III will operate simultaneously with the dashboard lightning. See chapter 9.1 for settings

Option: Connect the alarm relay as indicated

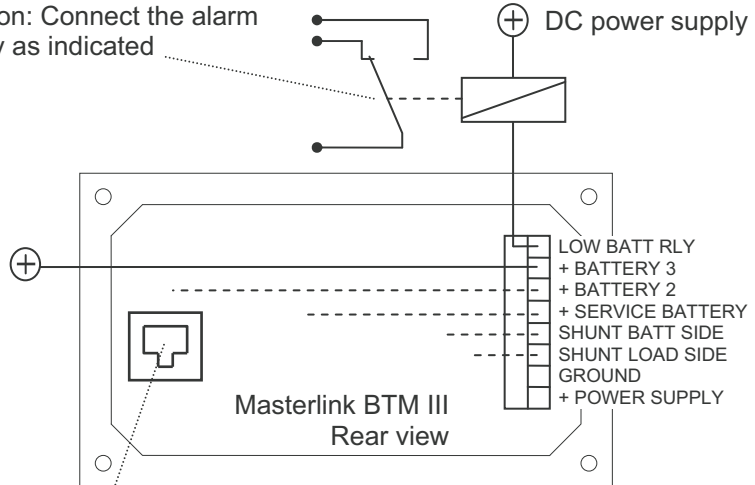

Option: Here a 6-pole RJ12 connector can be found for serial communication. Protocol QRS232. See chapter 11.6 for more information

6

Check all wiring.  
Then mount the panel into the grey installation housing

Mount this assembly into the instrumentation panel

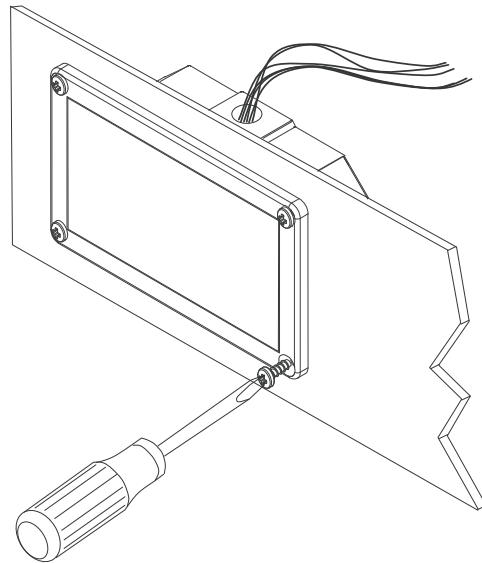
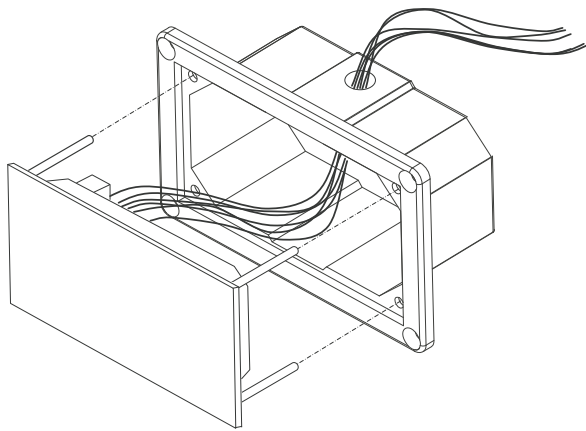

7

Commissioning



If all wiring is OK:

- Install the 2 A-T fuses of the voltage sense wires
- Place all battery fuses.
- Proceed with chapter 5, "FIRST START-UP" to synchronize the Masterlink BTM III in accordance with the electrical installation.

## 5 FIRST START-UP

### 5.1 LANGUAGE SETTING

NOTE: For each step below you need to finish within 60 seconds; otherwise the *Masterlink BTM-III* returns to the main menu again

Take the steps below to select the desired language.  
Example: language = CASTELLANO (Spanish)

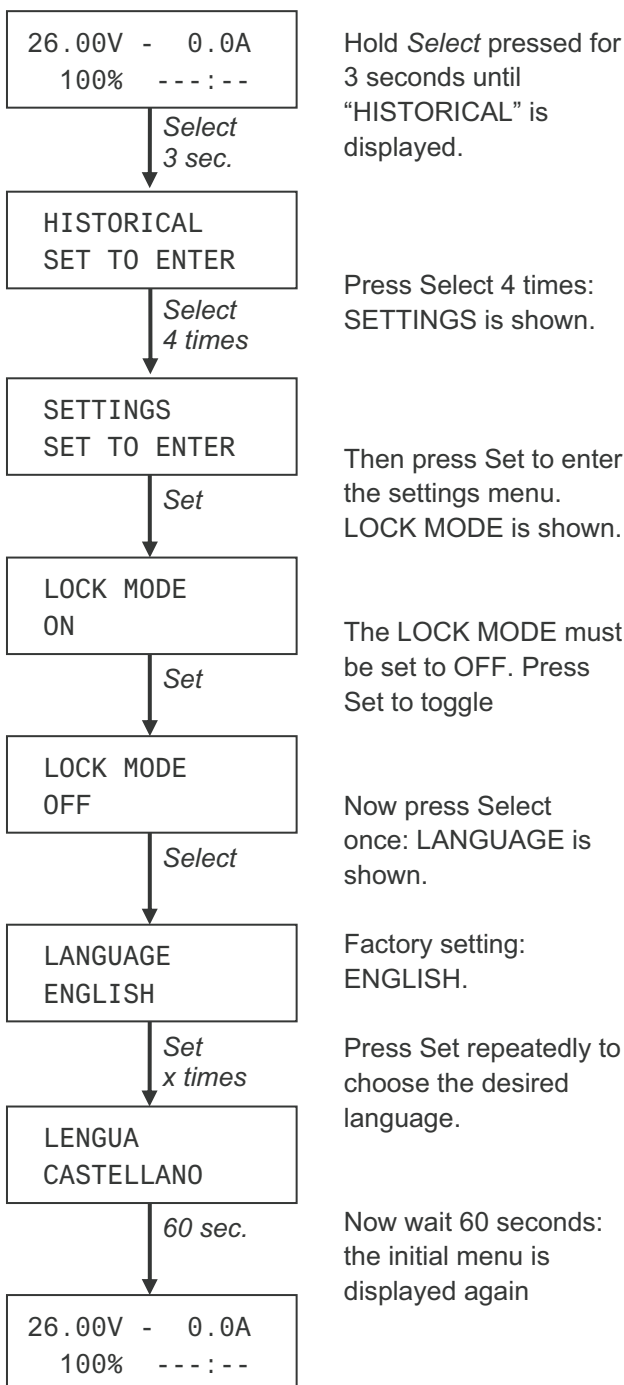

### 5.2 SYNCHRONISATION

Although the *Masterlink BTM-III* is for many items "self-learning", it is necessary to synchronise it in accordance with the electrical installation. Before synchronisation the batteries must be charged for at least 24 hours with an appropriate charger to be sure the batteries are 100% full.

Section 5.2.1 explains how to change a displayed value.

Section 5.2.2 shows the minimum required adjustments for battery bank 1.

Required settings for both battery bank 2 and 3 are described in chapter 5.2.3. As there is no measurement of the current by means of a shunt, synchronisation of battery banks 2 and 3 is a little more extended

See chapter 9 and 10 for more information about configuration of the *Masterlink BTM III*.

#### 5.2.1 Adjustment of values

During configuration an arrow can be displayed in the right part of the display. See example below.

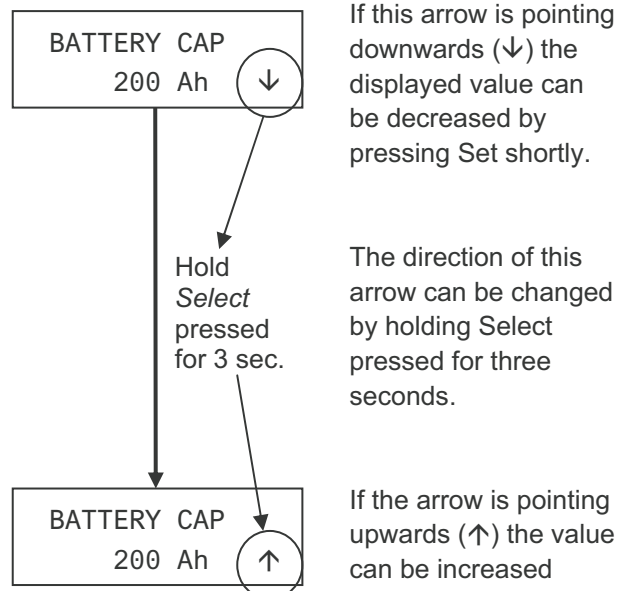

### 5.2.2 Settings for battery bank 1 (Service battery)

The following parameters must be adjusted for the service battery (battery bank 1):

- Name of the battery bank; example: POWER BANK
- Nominal battery voltage; example: 24V
- Nominal capacity of the installed batteries; example: 225Ah

NOTE: displayed values may differ

Steps:

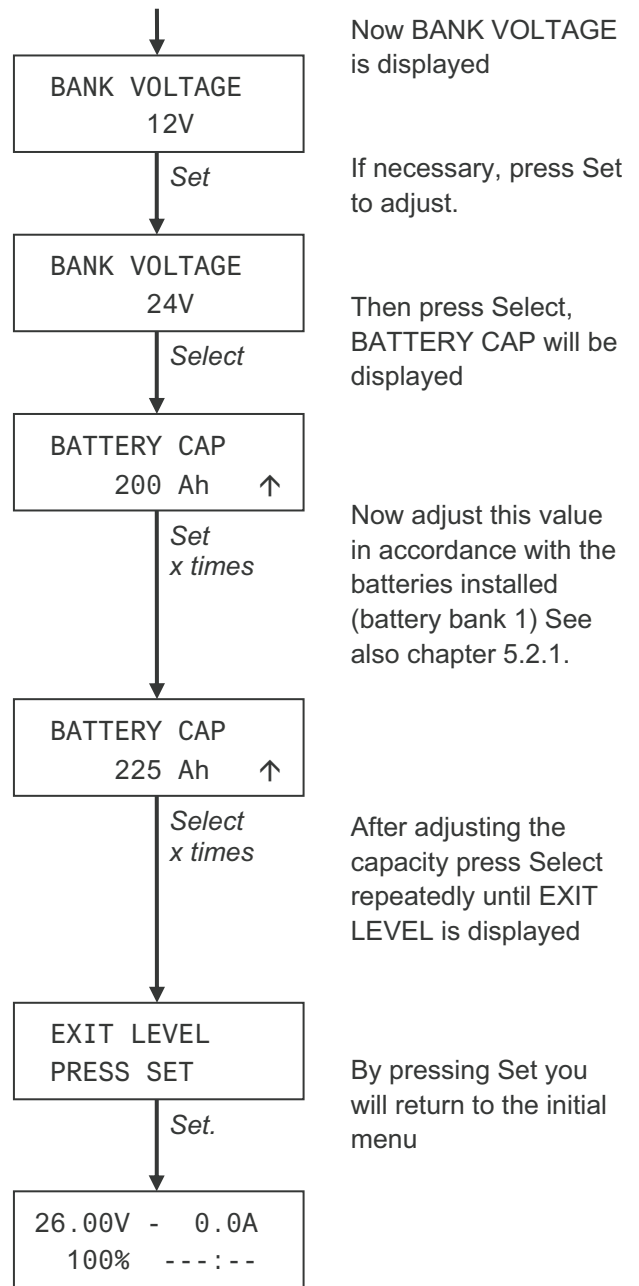
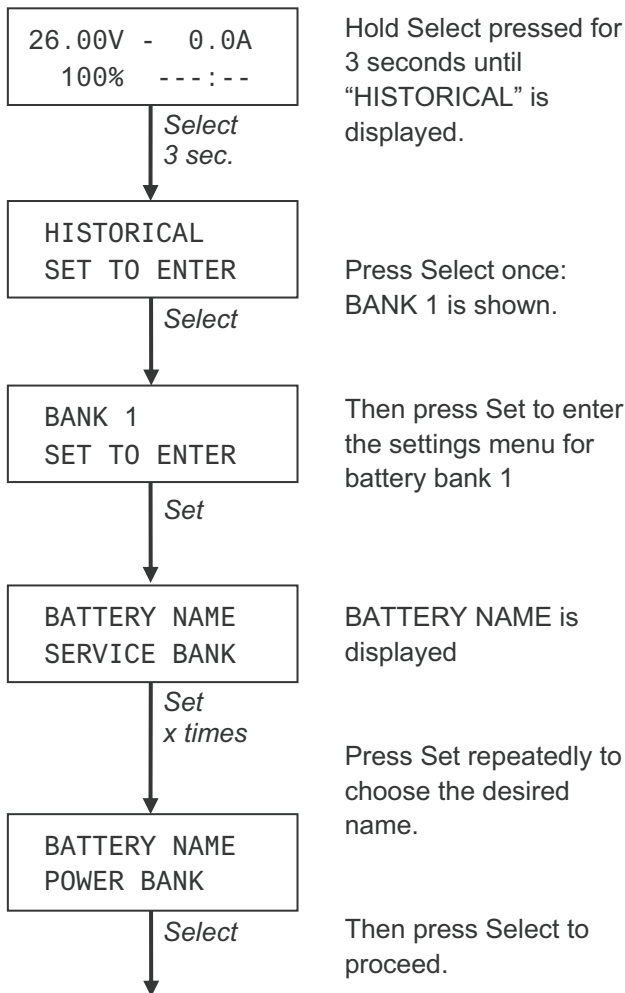

**5.2.3 Settings for battery bank 2 and 3**

The following parameters must be adjusted for battery banks 2 and 3:

- Name of the battery bank; example: BOWTHRUST BANK
- Nominal battery voltage; example: 12V

**NOTES:**

- Below shown values may differ.
- See chapter 9 and 10 for advanced settings

The way to adjust these settings is identical for both battery bank 2 and 3. Steps:

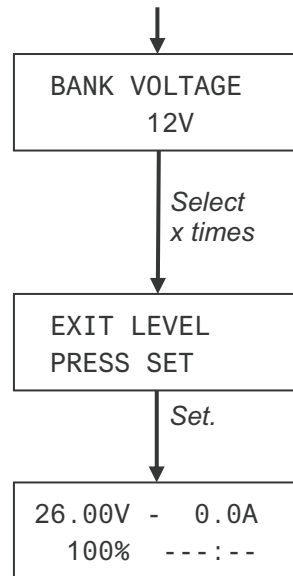
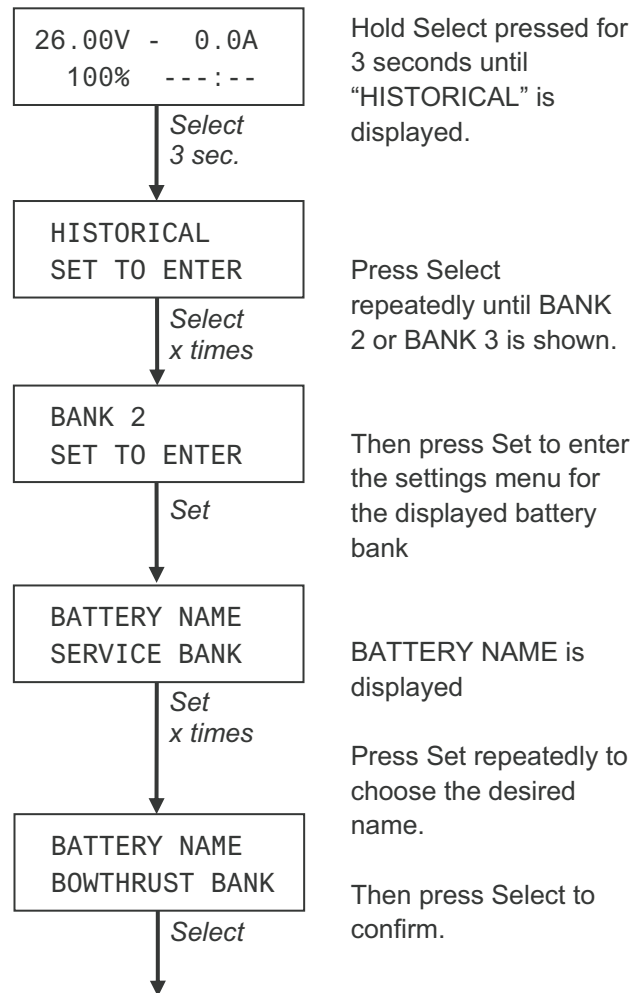

Now BANK VOLTAGE is displayed (If necessary press Set to adjust)

After adjustment press Select repeatedly until EXIT LEVEL is displayed

By pressing Set you will return to the initial menu

## 6 MAIN MENU

This chapter describes the functions of the main menu. If none of the buttons was touched for 60 seconds, the *Masterlink BTM-III* automatically returns to this menu. It offers a quick status overview of the battery banks. It is immediately accessible by pressing Select shortly. None of the displayed information can be modified at this menu.



Touch the Select button shortly to scroll through the levels as described below

25.54V - 29.3A  
42% 25:14

Select

CAP. CONSUMED  
- 86 Ah

Select

13.6 24.5 12.6V  
100%

Select

POWER BANK-1  
13.6V SOC:100%

POWER BANK-2  
24.5V

POWER BANK-3  
12.6V

Select

Back to *initial level*  
(chapter 6.1)

### 6.1 INITIAL LEVEL

When the *Masterlink BTM-III* is in rest, the initial level is displayed. It shows the following parameters of battery bank 1:

- Left hand top corner: Voltage at the terminals (V).
- Right hand top corner: Current (Amps) flowing in or out the battery. A negative value means that the battery is being discharged.
- Left-hand lower corner: State Of Charge (SOC) in %. This readout shows the actual amount of energy left in the battery. This percentage is also displayed by means of the LED bar.
- The remaining time before the battery will be empty (right hand lower corner). Maximum reading during a discharge: 480 Hours (> 20 days). During charging it shows “- -: - -”.

### 6.2 CONSUMED AMPHOURS

The next level shows how many Amp-hours (Ah) are consumed from battery bank 1. During charging this value shows how many Ah's are still necessary to bring the battery up to a 100 % State Of Charge again. (0 Ah consumed). This value is compensated by the Charge Efficiency Factor (C.E.F.)

### 6.3 SHORT MENU (VOLTAGE AND SOC)

The short menu gives a quick status overview of all battery sets simultaneously. It shows:

- Battery voltage for each battery
- State Of Charge (SOC) for battery bank 1. The SOC for battery bank 2 and 3 is only shown if visualisation of SOC 2 + 3 is enabled (see chapter 10.16)

### 6.4 LONG MENU (SOURCE NAME AND VALUES)

For each battery bank the name of the DC battery bank can be displayed together with the actual voltage and State of Charge. The SOC for battery bank 2 and 3 is only shown if visualisation of SOC 2 + 3 is enabled (see chapter 10.16)

Note: these data is not shown if the Battery name of a battery bank is set to “Not used” or “AUTO BACKLIGHT” (see chapter 9.1 for settings)



## 7 NAVIGATION THROUGH THE SUBMENUS

From the Main Menu of the *Masterlink BTM-III* several submenus can be accessed for adjustment of settings



**CAREFUL!**

Invalid settings of the *Masterlink BTM-III* can cause serious damage to your batteries. Adjustments of settings may be undertaken by authorised personnel only!



From the main menu (see chapter 6), hold Select pressed for approximately 3 seconds to get access to the submenus.



Press Select shortly to navigate along the submenus. Press Set shortly to enter the displayed submenu.

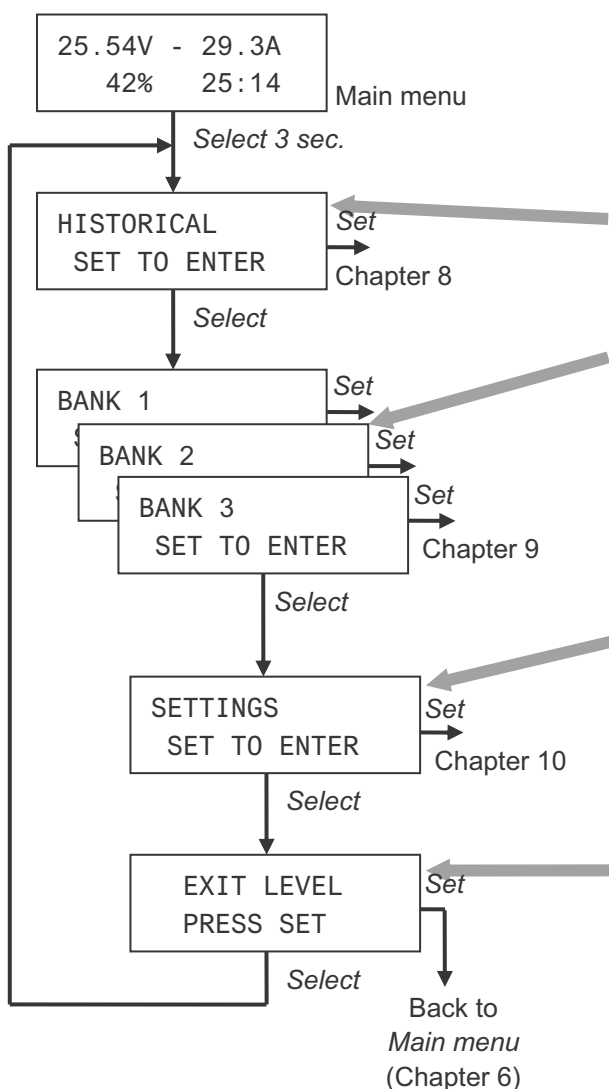

The submenus are:

Historical data menu (see chapter 8). This menu shows the history of your battery set(s).

Battery Bank menus (1, 2 and 3) (see chapter 9). These menus are used to adjust the *Masterlink BTM-III* in accordance with the specifications of each battery set and to adjust the trigger points for the alarm function of each battery set.

Settings menu (see chapter 10). Used for general settings like language, energy save mode and advanced settings for each battery bank. In the settings menu you also have the possibility to reset the *Masterlink BTM-III* back to the factory settings.

From the exit level you can return to the initial level of the main menu by pressing Set shortly. Also if none of the buttons was touched for 60 seconds, the *Masterlink BTM-III* returns to the main menu (Chapter 6)

## 8 HISTORICAL DATA MENU

To know the history of your battery banks set can be very useful. It will help you to check if the battery is has the right capacity for the application, and how long the battery can be used before it needs to be replaced. This can be done by reading the number of cycles the battery has used, and the efficiency (C.E.F.) of the battery. The memory back up system of the *Masterlink BTM-III* makes this data available even if the power supply of the meter removed or, if the battery completely discharged to 0 Volts.

See chapter 7 to enter the historical data menu



Touch *Select* shortly to scroll through the levels as described below. When no button is touched during 60 seconds, the display returns to the main menu (chapter 6) automatically

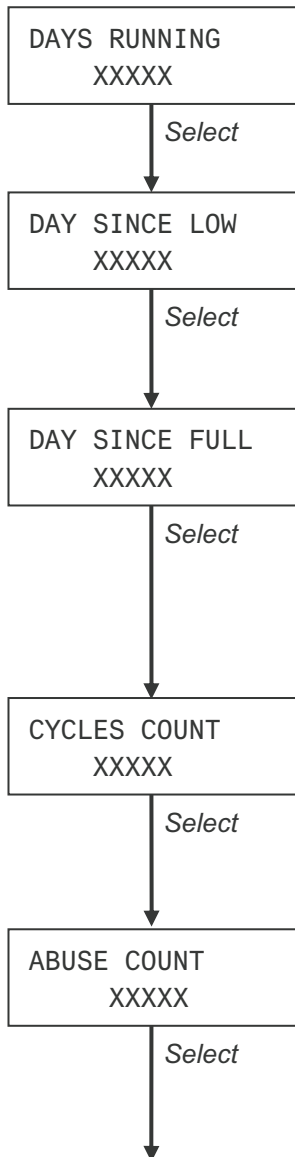

### 8.1 TIME SINCE START-UP

This function displays the total number of days since the *Masterlink BTM III* was powered. See chapter 10.6 if you want to reset this value.

### 8.2 TIME SINCE LAST LOW BATTERY ALARM

This function tells you when the battery alarm was triggered for the last time. See chapter 11.1 for explanation of the battery alarm function. See chapter 10.6 if you want to reset this value.

### 8.3 TIME SINCE LAST FULL CHARGE

This screen shows the number of days since battery bank 1 was charged up to 100% for the last time. Incomplete charges (less than 100%) may damage your batteries. Therefore the batteries must be charged to the full 100% regularly, at least every 30 days. See chapter 10.6 if you want to reset this counter.

### 8.4 CYCLES COUNT

This screen shows the total number of cycles of battery bank 1. See chapter 10.6 if you want to reset this counter.

### 8.5 ABUSE CYCLES

Slow and deep discharges below the battery's end voltage can reduce the expected lifetime of your batteries dramatically. This screen shows the number of abuse cycles of battery bank 1  
A large number of abuse cycles might indicate small users that stayed connected during a long period (for instance during wintertime). Get your electrical installation examined by a qualified installer if abuse cycles happen more than once!  
See chapter 10.6 if you want to reset this counter.

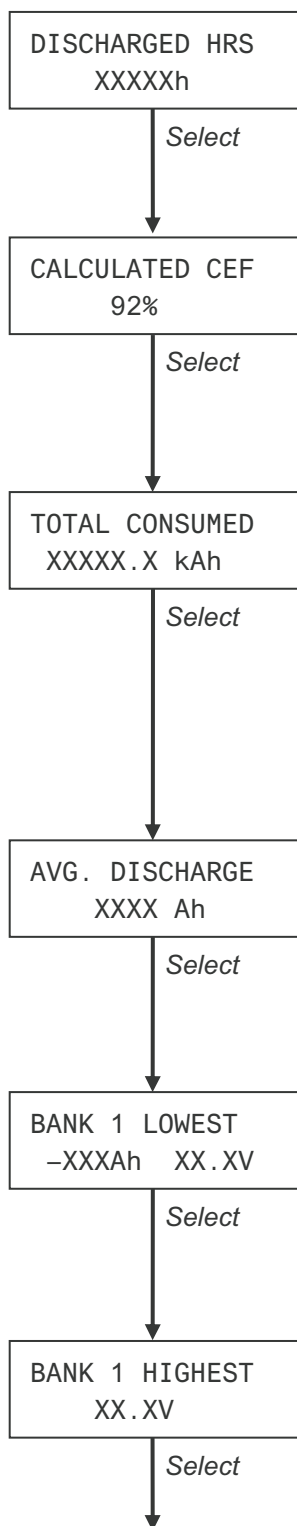

**8.6 DISCHARGED TIME**

This screen shows the total number of hours (after a delay of 12 hours) when the SOC of battery bank 1 was below 20% SOC. This value should be as low as possible, as batteries should be recharged immediately after a discharge.

**8.7 CALCULATED VALUE FOR THE CEF**

This screen shows the CEF that was calculated for battery bank 1. This value is used for the calculation of the consumed Amphours (section 6.2), the time remaining function (section 6.1) and the State Of Charge (SOC) (section 6.3 and 6.4) See chapter 11.2 for explanation of the CEF

**8.8 TOTAL AMPERE HOURS CONSUMED**

This counter displays the total amount of Amphours consumed from battery bank 1. It is like the km-counter of your battery. But like a car, not only the number of Km's tell something about its condition. The condition is also influenced by the way the car was treated. So it does for your batteries. See chapter 10.6 if you want to reset this counter.

**8.9 AVERAGE DISCHARGE BATTERY BANK 1**

This value shows the average discharge of battery bank 1. This value should be less than half of the installed battery capacity, else the capacity is too low. See chapter 10.6 if you want to reset this value.

**8.10 DEEPEST DISCHARGE BATTERY BANK 1**

Shows the deepest discharge, together with the voltage at the time this deepest discharge was recorded. The deepest discharge should never be below the rated capacity of the battery as specified by the battery manufacturer. See chapter 10.6 if you want to reset this value.

**8.11 HIGHEST VOLTAGE BATTERY BANK 1**

Shows the highest voltage that was recorded. This voltage should never be above the maximum charging voltage as specified by the battery manufacturer. See chapter 10.6 if you want to reset this value.

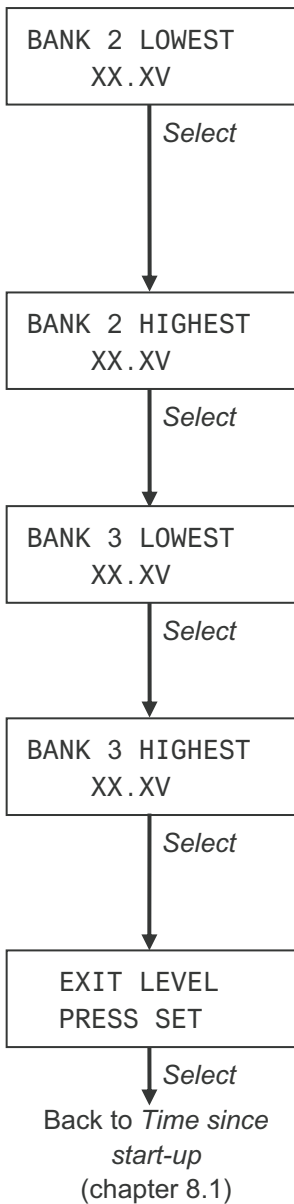

**8.12 DEEPEST DISCHARGE BATTERY BANK 2**

Shows the lowest voltage that was recorded. This value should never be below the final discharge voltage as specified by the battery manufacturer. Not shown if BATTERY NAME is set to "NOT USED" (see chapter 9.1). See chapter 10.12 if you want to reset this value.

**8.13 HIGHEST VOLTAGE BATTERY BANK 2**

As with battery bank 1. See 8.11 Not shown if BATTERY NAME is set to "NOT USED" (see chapter 9.1). See chapter 10.12 if you want to reset this value

**8.14 DEEPEST DISCHARGE BATTERY BANK 3**

As with battery bank 2. See 8.12. Not shown if BATTERY NAME is set to "NOT USED" or "AUTO BACKLIGHT" (see chapter 9.1). See chapter 10.15 if you want to reset this value.

**8.15 HIGHEST VOLTAGE BATTERY BANK 3**

As with battery bank 1. See 8.11 Not shown if BATTERY NAME is set to "NOT USED" or "AUTO BACKLIGHT" (see chapter 9.1). See chapter 10.15 if you want to reset this value.

**8.16 EXIT LEVEL**

Press Set shortly to return to the initial level of the main menu. (see chapter 6). Also, if none of the buttons was touched for 60 seconds, the *Masterlink BTM-III* returns to the main menu

## 9 BATTERY BANK MENUS 1, 2 AND 3

This menu is used to adjust the *Masterlink BTM-III* according to the voltage and capacity of the batteries. The way settings are made is almost identical for each of the battery sets. Any differences are described in the sections below.

See chapter 7 to enter the settings menu of battery bank 1, 2 or 3



Touch Select shortly to scroll through the levels as described below. When no button is touched during 60 seconds, the display returns to the main menu (chapter 6) automatically.



NOTE: During configuration an arrow can be displayed in the right part of the display. If the arrow is pointing downwards (↓) the displayed value can be decreased by pressing Set shortly. If the arrow is pointing upwards (↑) the value can be increased

The direction of this arrow can be changed by holding Select pressed for three seconds.

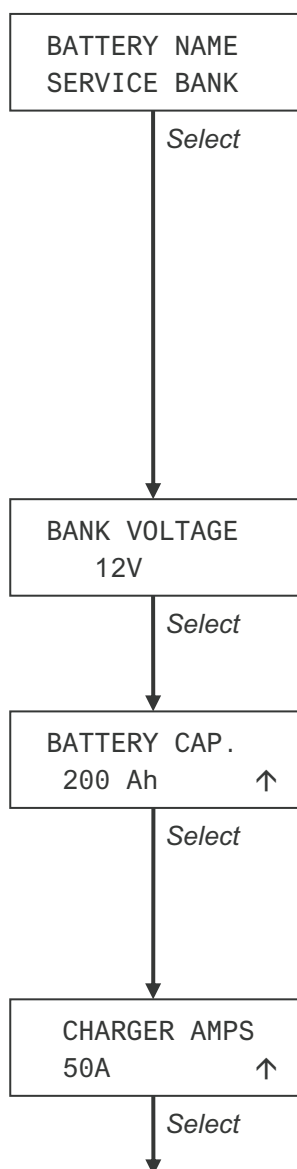

### 9.1 BATTERY BANK NAME

Adjust the desired source name by pressing Set. See chapter 11.8 for a listing of the available names

Adjust this value to "NOT USED" if there is no battery bank connected to this particular DC input (only possible for battery bank 2 and 3).

If only one or two battery banks need to be monitored, the DC-input for battery bank 3 can be connected to power supply of the dashboard lighting. Then, if AUTO BACKLIGHT was selected, the backlight of the *Masterlink BTM-III* and the dashboard lightning will switch on simultaneously.

If "NOT USED" or "AUTO BACKLIGHT" was selected, data from the below mentioned sections will not be shown

### 9.2 NOMINAL BATTERY VOLTAGE

Select the nominal voltage (12V→24V) by pressing the Set button. Default value: 12V. This value is automatically adjusted to 24V when the input voltage is more than 20V.

### 9.3 BATTERY CAPACITY

For an accurate reading of the time remaining function, and the capacity consumed in % of the installed capacity, this level must be set according the capacity of the battery installed. Use the rating for a 20 hrs discharge (C 20).

Default setting: 200Ah

Note for battery bank 2 and 3: only shown if visualisation of SOC 2 + 3 is enabled (see chapter 10.16)

### 9.4 NOMINAL CHARGER CURRENT

Only displayed for battery bank 2 and 3 and only shown if visualisation of SOC 2 + 3 is enabled (see chapter 10.16).

For a more accurate calculation of the State Of Charge the rated charger current as specified by the manufacturer of the battery charger must be entered here.

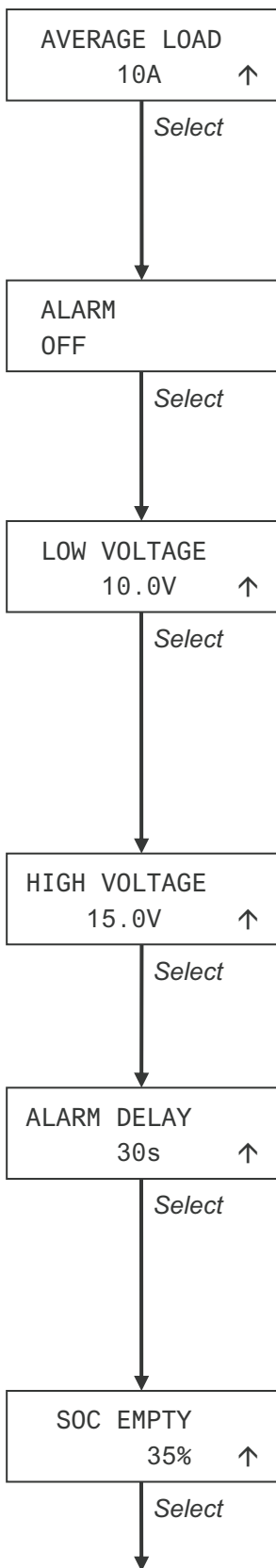

### 9.5 AVERAGE DISCHARGE AMPS

Only displayed for battery bank 2 and 3 and only shown if visualisation of SOC 2 + 3 is enabled (see chapter 10.16).

For a more accurate calculation of the State Of Charge the expected average discharge Amps must be entered. This value should equal the expected average discharge current during the time of discharge (so not during 24 hours).

### 9.6 ALARM FUNCTION ON/OFF

Press Set to enable (ON) or disable (OFF) the alarm function. If this function is set to ON, the operation of the external relay will be enabled

The factory setting: off

### 9.7 LOW VOLTAGE SETPOINT

The “low voltage set point marks the voltage threshold of too low battery. If the battery voltage drops below this value, the alarm function will be activated after the “alarm delay time” has elapsed; see 9.9.

To enable/disable the alarm function see 9.6

Factory setting: 10.0v/20.0V depending on the nominal battery voltage

Adjustable range: 8.0...12.9V/16.0...25.8V.

### 9.8 HIGH VOLTAGE SETPOINT

When the battery voltage rises above this level, the alarm function will be triggered without delay.

Factory setting: 15.0V/30.0V depending on the nominal battery voltage

Adjustable range: 13.0...16.0V/26.0...32.0V.

### 9.9 ALARM DELAY TIME

The “alarm delay time” can be set to delay the alarm function when the DC-voltage drops below the low voltage set point. This delay is to prevent a false alarm as a result of a temporary voltage drop, because of switching on a heavy load.

Factory setting: 30 seconds

Adjustable range: 1...60 seconds

### 9.10 STATE OF CHARGE LEVEL FOR “EMPTY BATTERY”

This level marks the state of charge (SOC) at which the battery is considered to be empty. If the State of Charge drops below this level the battery alarm function will be activated.

Note for battery bank 2 and 3: only shown if visualisation of SOC 2 + 3 is enabled (see chapter 10.16)

Factory setting: 35%

Adjustable range: 0...80%

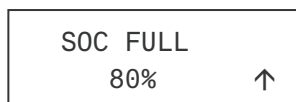

Select

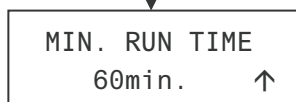

Select

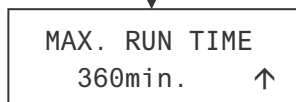

Select

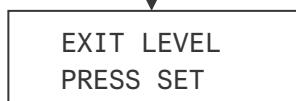

Select

Back to *battery bank name*  
(chapter 9.1)

### 9.11 STATE OF CHARGE LEVEL FOR “FULL BATTERY”

If the state of charge rises above this level, the battery is considered to be almost full. At this level the battery alarm function switches off again

Note for battery bank 2 and 3: only shown if visualisation of SOC 2 + 3 is enabled (see chapter 10.16)

Factory setting: 80%

Adjustable range: 70 to 90 %

### 9.12 MINIMUM RUNTIME ALARM FUNCTION

The “minimum run time” setting is the minimum time that the alarm will stay activated. For example: if the battery drops below the settings for the “low voltage set point” but is charged directly afterwards, the alarm will stay activated for another 60 minutes (factory setting) even if the battery is fully charged (more than the state of charge level for “full battery”; see 9.11)

Factory setting: 60 min

Adjustable range: 1...240 min

### 9.13 MAXIMUM RUNTIME ALARM FUNCTION

If the alarm function does not meet the state of charge level for “full battery” (see 9.11) it will switch off after the maximum runtime has elapsed. This means that the alarm function will be switched off, even when the batteries have not been recharged yet.

Factory setting: 360 minutes (6 hours)

Adjustable range: 60...1440 min in steps of 60 min.

Note: if the setting for “minimum run time” is set to a higher value than the “maximum runtime”, the alarm runtime will not be limited by this setting. See also 11.1

### 9.14 EXIT LEVEL

From here you can return to the main menu (chapter 6) by pressing Set shortly. Also, if none of the buttons was touched for 60 seconds, the *Masterlink BTM-III* returns to the main menu.

## 10 SETTINGS MENU

The Settings Menu is used to adjust general settings like displayed language, energy save mode and advanced settings for each battery bank. Here you also have the possibility to reset the *Masterlink BTM-III* back to the factory settings

Refer to chapter 7 to get access to this menu



Touch Select shortly to scroll through the levels as described below. When no button is touched during 60 seconds, the display returns to the main menu (chapter 6) automatically.



NOTE: During configuration an arrow can be displayed in the right part of the display. If the arrow is pointing downwards (↓) the displayed value can be decreased by pressing Set shortly. If the arrow is pointing upwards (↑) the value can be increased

The direction of this arrow can be changed by holding Select pressed for three seconds.

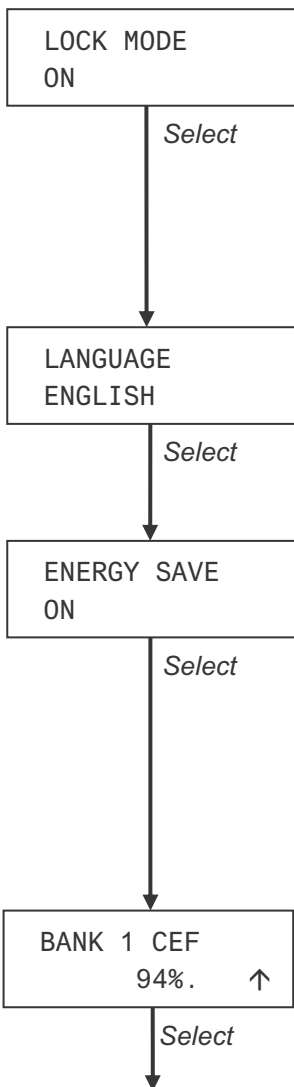

### 10.1 LOCK MODE

To protect the *Masterlink BTM-III* against unintended adjustment of set points, the lock mode is activated every time you leave the Settings menu. When activated (“ON”), the settings mentioned in this chapter cannot be changed.

Press Set to toggle the lock mode.

Factory setting: ON

### 10.2 LANGUAGE

Press Set to choose the desired language (did you switch OFF the lock mode first? See 10.1). See specifications (chapter 13) for a listing of the available languages

Factory setting: ENGLISH

### 10.3 ENGERGY SAVE MODE

If the Energy Save mode is enabled (ON), the backlight of the display and the LED-bar will go off automatically if the buttons are not touched for 1 minute. As soon as one of the buttons is touched, the display’s backlight and the LED-bar will be lit again for an easy reading of the display.

Press Set to toggle the Energy Save mode

Factory setting: ON

Operation of the energy save mode is overruled if BATTERY NAME is set to “AUTO BACKLIGHT” (see chapter 9.1).

### 10.4 CHARGE EFFICIENCY FACTOR BATTERY BANK 1

Here you can enter the initial value for the Charge Efficiency Factor of battery bank 1. See 11.2 for additional information about the Charge Efficiency Factor.

Factory setting: 94%

Adjustable range: 70...96%



BANK 1 PEUKERT  
1.27. ↑

Select

BANK 1 RESET  
PRESS SET 3SEC

Select

BANK 1 RETURN  
2.0%

Select

BANK 1 FLOAT  
13.2V

Select

## 10.5 PEUKERT EXPONENT BATTERY BANK 1

The Peukert exponent can be set according to the type of battery installed (see chapter 11.3 for more information). Do not change this setting without extended knowledge of the installed batteries

Factory setting: 1.27

Adjustable range: 1,01 ...1,50

## 10.6 RESET HISTORICAL DATA BATTERY BANK 1

All historical data of battery bank 1 (parameters as specified in chapter 8.1 till 8.11) will be reset when *Set* is held for three seconds.

If new batteries are installed, the historical data of the old batteries needs to be erased to leave only historical data from the newly installed batteries.

## 10.7 CHARGE AMPS FOR FULL BATTERY

In order to check if the battery is fully charged several parameters must be met before the *Masterlink BTM-III* will consider the battery fully charged. See chapter 11.4 for additional information.

This percentage expresses the charge current related to the battery capacity (C20) below which the battery is considered to be full, provided the float voltage (see chapter 10.8) is met as well. Example: If the battery capacity is 200Ah, and this percentage is set to 2.0%, the battery is considered to be full when the charge current has dropped below  $200 \times 2.0\% = 4$  Amps.

If the battery becomes a lot older (beyond its normal lifetime) it might start to consume more current when the battery is fully charged. This means that this set point needs to be changed to a higher value if old batteries are used which are beyond their economical life but have not been replaced yet.

Range: 1...10%

Default setting: 2.0%

## 10.8 FLOAT VOLTAGE

Another parameter that must be reached before the *Masterlink BTM-III* will consider the battery fully charged. This voltage must be set according to the lowest float voltage of all the charging devices in the system. This means for example if the float output voltage of your battery charger is 13.25V and the output voltage of your alternator is 13.8V the voltage must be set just below the lowest voltage i.e. below 13.25 volt.

Lower this value by 0.1V if your *Masterlink BTM-III* does not return to 100% after a long period of charging,

See also chapter 11.4 for additional information.

Factory setting: 13.2V/26.4V depending on the nominal battery voltage. When a Mastervolt battery charger is applied, you don't need to change this value.

Adjustable range: 12.0...14.0V/24.0...28.0V

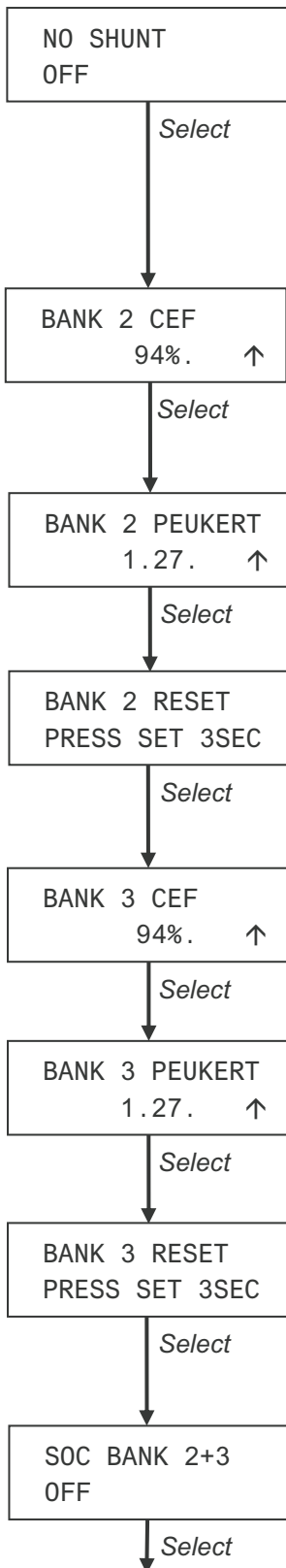

**10.9 BATTERY BANK 1: NO SHUNT**

For the most accurate readout of the battery bank 1 the use of a shunt is mandatory. If it is not possible to use a shunt, this setting must be switched to ON. If switched to ON, functions and specifications of battery bank 1 are as indicated for battery bank 2  
 Factory setting: OFF

**10.10 CHARGE EFFICIENCY FACTOR BATTERY BANK 2**

Here you can specify the (fixed) value of the C.E.F. for battery bank 2. See chapter 11.2 for more information about the Charge Efficiency factor

**10.11 PEUKERT EXPONENT BATTERY BANK 2**

As with battery bank 1. See 10.5

**10.12 RESET HISTORICAL DATA BATTERY BANK 2**

All historical data of battery bank 2 (chapter 8.12 till 8.13) will be reset when *Set* is held for three seconds.

**10.13 CHARGE EFFICIENCY FACTOR BATTERY BANK 3**

As with battery bank 2. See 10.10.

**10.14 PEUKERT EXPONENT BATTERY BANK 3**

As with battery bank 1. See 10.5

**10.15 RESET HISTORICAL DATA BATTERY BANK 3**

All historical data of battery bank 3 (chapter 8.14 till 8.15) will be reset when *Set* is held for three seconds.

**10.16 VISUALISATION OF SOC FOR BATTERY BANK 2 + 3**

An accurate readout of the State Of Charge (SOC) is only possible by using a shunt, as with battery bank 1. However with battery bank 2 and 3 a rough estimation of the SOC can also be made by means of a built-in calculation algorithm.  
 If you want to make the SOC visible for battery bank 2 and 3, this value must be set to ON  
 Factory setting: OFF

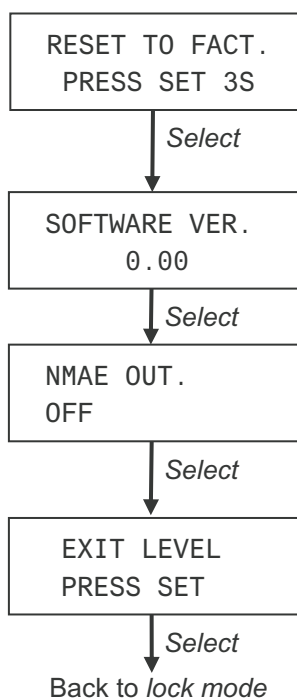
**10.17 RESET TO FACTORY SETTINGS**

Here all settings will be reset to the original factory settings when *Set* is held for three seconds.

**10.18 SOFTWARE VERSION**

This level shows the installed software version; this value cannot be changed

**10.19 NMAE OUT: ON/OFF**

See chapter 11.9.

Factory setting: OFF

**10.20 EXIT LEVEL**

From here you can return to the main menu (chapter 6) by pressing *Set* shortly. Also, if none of the buttons was touched for 60 seconds, the *Masterlink BTM-III* returns to the main menu.

## 11 ADDITIONAL INFORMATION

### 11.1 BATTERY ALARM FUNCTION

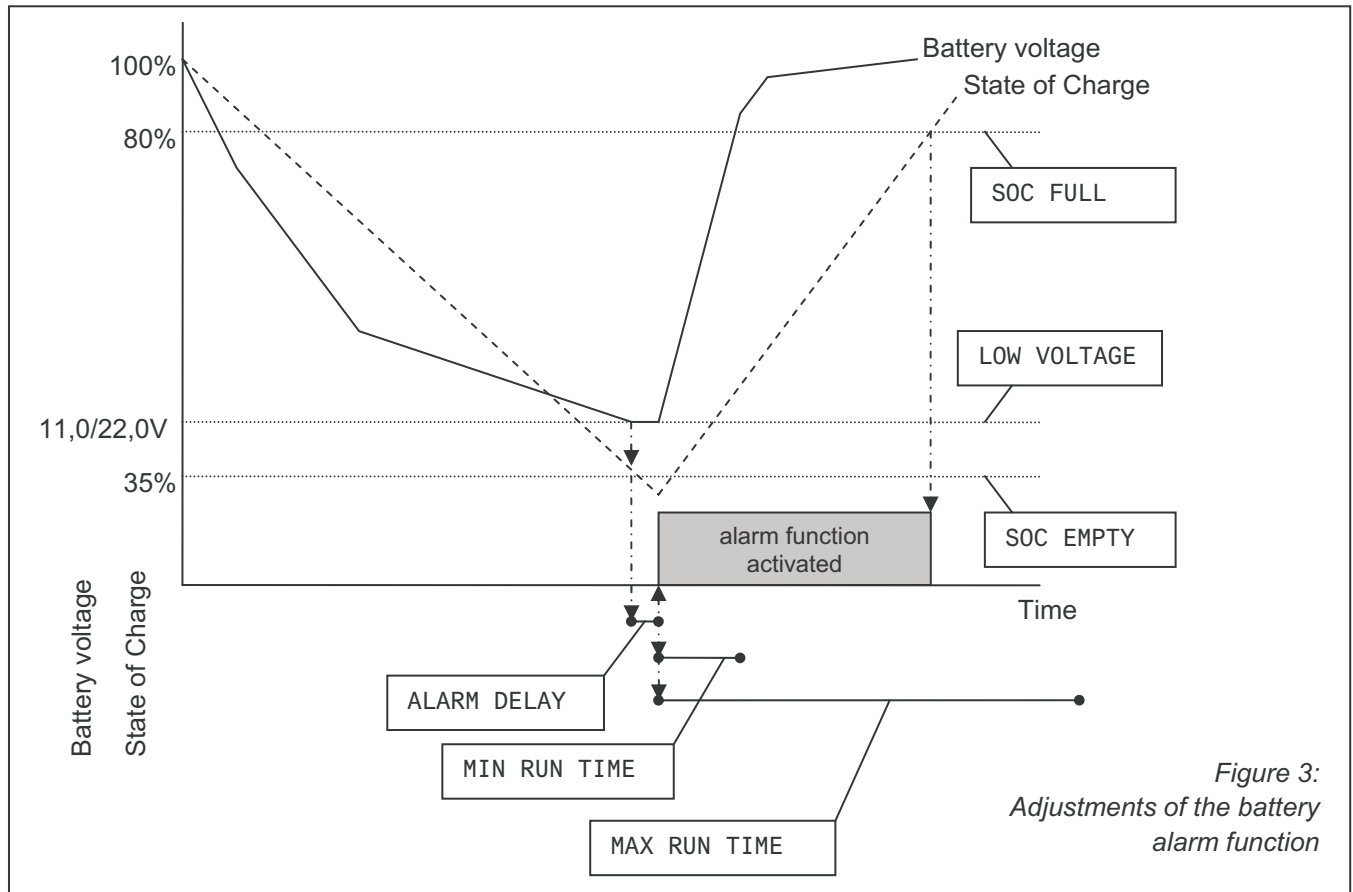

Figure 3:  
Adjustments of the battery  
alarm function

The *Masterlink BTM-III* continuously monitors the state of charge of the batteries. If the State Of Charge drops below a pre-set value or the battery voltage is either too high or too low, the alarm function is activated. For external alarm a small relay can be applied (see installation instructions, chapter 4). This relay can be used for instance to activate an audible alarm or to switch on a battery charger or generator set

If an external relay is applied, make sure that the alarm function is enabled (see chapter 9.6)

The Alarm function is activated when one of the following is conditions met:

- 1 The actual battery voltage is below the low voltage setpoint (chapter 9.7) for at least the “alarm delay time” (chapter 9.9), or
- 2 The actual state of charge is below the State of Charge level for “empty battery” (chapter 9.10), or
- 3 The actual battery voltage is higher than the high voltage setpoint (chapter 9.8).

The Alarm function is switched off again if one of the following is conditions met:

- 1 The “maximum runtime” (chapter 9.13) has elapsed, or
- 2 The “minimum runtime” has elapsed (section 9.12) and the actual state of charge is higher than the “State of Charge level for full battery” (section 9.11)

### 11.2 CHARGE EFFICIENCY FACTOR (C.E.F.)

Every battery has a total efficiency. This means that there must be more Ah charged into the battery than can be consumed. This ratio is expressed by means of the Charging Efficiency Factor (CEF). It is used to correct the calculation of the consumed Amphours (section 6.2) and the time remaining function (chapter 6.1)

A standard wet type lead acid battery has an efficiency of approx. 89 % while an AGM has an efficiency of approx. 95 and a gel type battery approx. 94 %. The efficiency of a battery is improved after it has been used for 5-10 cycles. For the rest of

the lifetime of the battery the efficiency will slowly decline depending on its age and the number of discharge cycles. If an efficiency of 70 % is reached, it will basically mean that the battery is at the end of its lifetime and needs to be replaced.

For each battery set connected to the *Masterlink BTM-III* the setting of the Charge Efficiency Factor can be specified. See chapter 10. Only with battery set 1, the CEF is continuously recalculated by the *Masterlink BTM-III* itself (after two recharges up to 100% with a proceeding discharges of at least 5%). This recalculated value (see 8.7) is used for new calculations of the Amphours, the time remaining function and the State Of Charge (SOC)

### 11.3 PEUKERT EXPONENT

Standard batteries are rated for a 20-hour discharge. This means that a 100 Ah battery can supply 5 Amps for 20 hours before a voltage of 1,75 V/cell (i.e. 10.5V for 12V batteries / 21.0V for 24V batteries) is reached. If the discharge current is higher, for example 10 amps the battery will not be able to supply the full 100 Ah. In this case the voltage of 1,75 volt/cell or 10.5/21.0V is reached before the battery has supplied its full 20-h rated capacity.

In fact the maximum time the battery can be used in the above mentioned example is approx. 8 hour i.e. 80 Ah

The Peukert equation describes the effect of different discharge rates on battery capacity and can be used to calculate the real available capacity of a battery, if it is used above or below its 20 h rating. This equation is also used by the *Masterlink BTM-III* to calculate the time remaining function and the state of charge (SOC)

In normal circumstances it is not necessary to change the Peukert exponent. It will only be necessary if traction batteries e.g. on a forklift, are used. See chapter 10 to adjust the Peukert exponent for each battery bank.

### 11.4 STATE OF CHARGE.

The state of charge (see chapter 6) is expressed as a percentage. This value is automatically compensated by the charge efficiency factor (C.E.F.) and the Peukert exponent. When the battery is fully charged, the State of charge (see chapter 6) will be reset to 100%. A battery is considered to be fully charged if one of the following conditions is met:

- 1 (Battery bank 1 only) below parameters are met for at least 30 seconds:
  - All of the Ah's discharged are charged back into the battery (real counting without CEF)
  - The actual charge current is less than the setting for charge amps for full battery (see chapter 10.7).
- 2 For at least 4 hours the actual battery voltage is higher than the float voltage (see 10.8) *plus* 1.0 / 2.0 (at nominal battery voltage 12/24V)
- 3 For at least 8 hours the actual battery voltage is higher than the float voltage (see 10.8) *plus* 0.3 / 0.6V (at nominal battery voltage 12/24V)
- 4 For at least 12 hours the actual battery voltage is higher than the float voltage (see 10.8) *minus* 0.1 / 0.2V (at nominal battery voltage 12/24V)

### 11.5 REPLACEMENT OF BATTERIES

Refer to chapter 4 (Installation) if you want to replace the batteries.

If new batteries are installed, the historical data of the old batteries needs to be erased to leave only historical data from the newly installed batteries. See chapter 10 to reset the historical data for each battery bank. If necessary, do not forget to change the at setting of the nominal capacity (see chapter 9.3)

### 11.6 MASTERADJUST SOFTWARE

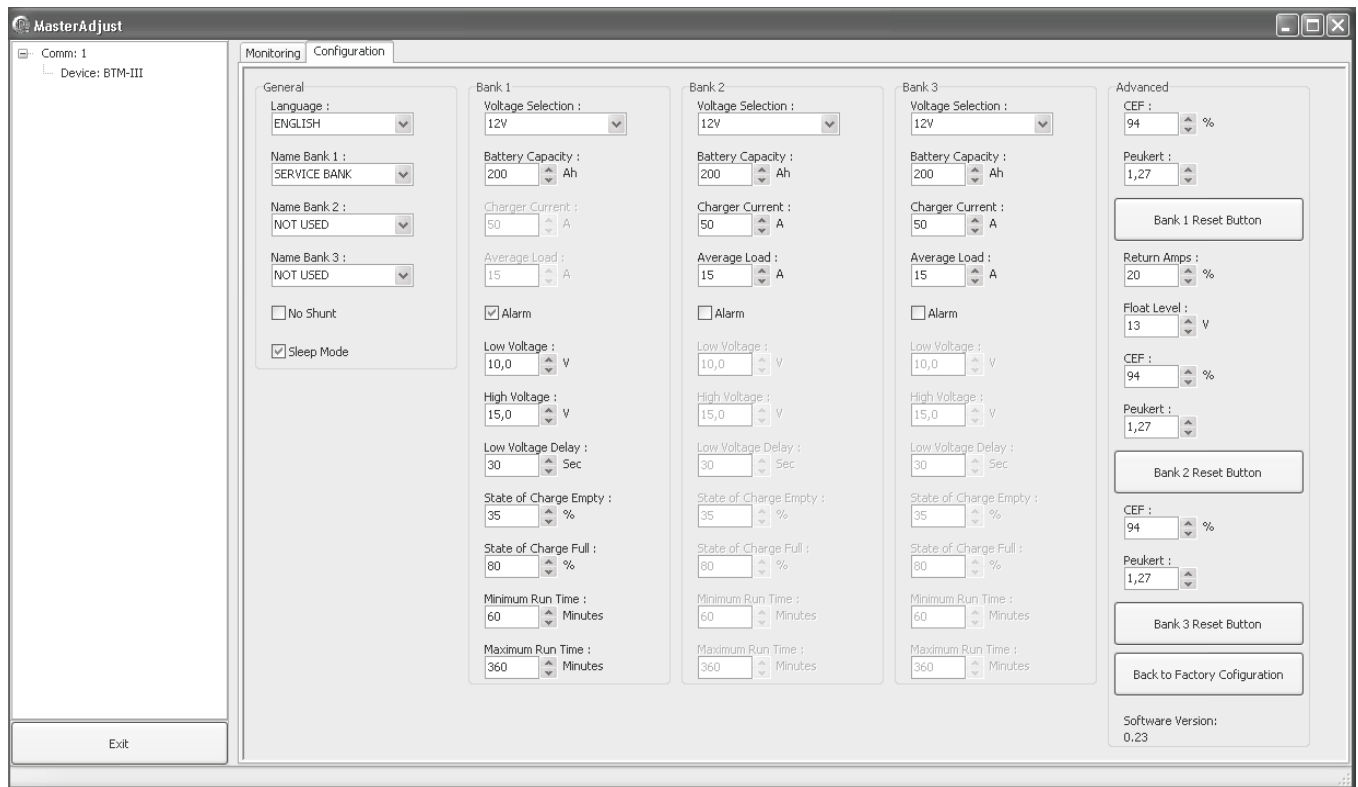

Figure 4

The Mastervolt *Masterlink BTM-III* can be configured and monitored by means of MasterAdjust software. Us of this software requires a PC-Link cable (art 21730100) or its galvanically isolated version (art 21730300). See ordering information.

The combination of the MasterAdjust software and the PC-Link cable can be used to monitor and configure different Mastervolt products, including the Masterlink BTM III. It allows you to read the measured data from your *Masterlink BTM-III* battery monitor and store these data to a file. With this file you can analyze the performance of your DC system and your batteries in particular.

The Data Control software can be downloaded from the Mastervolt website at [www.mastervolt.com](http://www.mastervolt.com)

See the user manual of the Data Control Software for detailed information

### 11.7 PEUKERT CALCULATOR

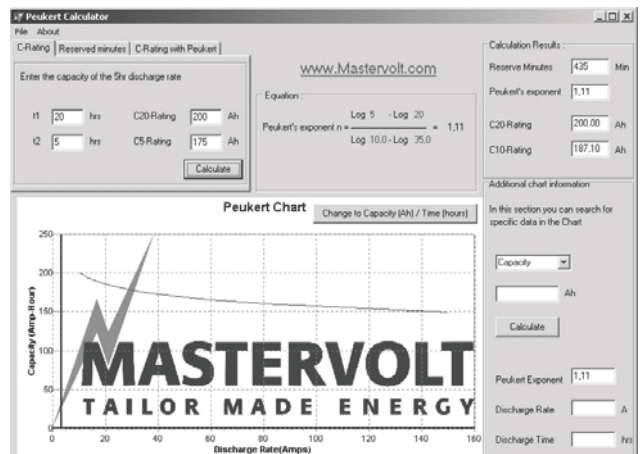

Figure 5

This handy software allows you to determine the Peukert coefficient of your battery set. Simply enter the details of two different discharging processes and the programme will immediately calculate both the Peukert coefficient and the C10 and C20 capacity

This software can be downloaded from the Mastervolt website at [www.mastervolt.com](http://www.mastervolt.com)

## 11.8 BATTERY NAMES

See chapter 5.2 and 9.1 for settings. Available names for the battery banks are:

Battery bank 1	Battery bank 2	Battery bank 3
SERVICE BANK	NOT USED	AUTO BACKLIGHT
STARTER BANK	SERVICE BANK	NOT USED
HOUSE BANK	STARTER BANK	SERVICE BANK
PORT BANK	HOUSE BANK	STARTER BANK
STARBOARD BANK	PORT BANK	HOUSE BANK
POWER BANK	STARBOARD BANK	PORT BANK
GEN.START BANK	POWER BANK	STARBOARD BANK
BOWTHRUST BANK	GEN.START BANK	POWER BANK
RADIO BANK	BOWTHRUST BANK	GEN.START BANK
12V SERVICES	RADIO BANK	BOWTHRUST BANK
OTHER BANK	12V SERVICES	RADIO BANK
	OTHER BANK	12V SERVICES
		OTHER BANK

## 11.9 NMEA0183 FORMAT

The NMEA0183 format of the *Masterlink BTM-III* shows: \$PMVBM,3,27.3,V,0000.2,A,100,%,00.0,V,00.0,V\*70

PMV	Proprietary format Mastervolt
BM	Battery Monitor
3	Version 3 (for three battery banks)
27.3V	Voltage battery bank 1
0000.2A	Charge current battery bank 1
100%	SOC battery bank 1 100%
00.0V	Voltage battery bank 2
00.0V	Voltage battery bank 3
*70	Checksum according to NMAE0183 requirements

## 11.10 ORDERING INFORMATION

Part number	Description
70904610	Grey installation housing *
39019052	Single shunt 500A/50mV*
70904180	Single shunt 1000A/100mV
21730100	PC link RS232-QRS232 (without galvanic isolation)
21730300	PC link RS232-QRS232 ISOLATED (with galvanic isolation)
6801601100	Cable 3x2x0.25 mm <sup>2</sup> twisted stranded wires (per meter)
6801601200	Cable 4x2x0.25 mm <sup>2</sup> twisted stranded wires (per meter)
6801601300	Cable 5x2x0.25 mm <sup>2</sup> twisted stranded wires (per meter)
6502001030	Modular RJ 12/ cross wired communication cable (6 m. / 19 ft.)
6502100100	Modular RJ 12/ cross wired communication cable (10 m. / 33 ft.)
6502100150	Modular RJ 12/ cross wired communication cable (15 m. / 48 ft.)

\* These parts are standard included with the delivery of the *Masterlink BTM-III*

Mastervolt can offer a wide range of products for your electrical installation, including AGM batteries, GEL batteries, DC distribution kits, battery switches, battery cables, battery terminals and Mastervision switchboards. See our website [www.mastervolt.com](http://www.mastervolt.com) for an extensive overview of all our products and free to download software for remote monitoring (see chapter 11.6)

## 12 TROUBLE SHOOTING

Contact your local Mastervolt Service Centre if you cannot correct a problem with the aid of the malfunction table below. See [www.mastervolt.com](http://www.mastervolt.com) for an extended list of Mastervolt Service Centres.

Failure	Possible cause	What to do
No display function	Error in the wiring	Check wiring for errors especially the DC power supply (chapter 4.2 step 4)
No current measurement for battery bank 1	Error in the wiring	Check wiring for errors especially the twisted wires between the shunt and the panel (chapter 4.2 step 4)
	No load connected.	Check the load.
Current measurement not accurate	Part of the load or charger is connected at the battery side of the shunt	Check whether all connections to the negative pole are connected at the load side of the shunt (chapter 4.2 step 3)
	Distortion on the shunt wiring	Replace wiring by twisted pair cable between the shunt and the panel (chapter 4.2 step 4). Keep this wiring away from other noise producing conductors!
	Corrosion on the shunt wiring	Replace wiring. Take adequate measures to avoid corrosion of the wires and connections!
Voltage reading shows 0,00	Error in the wiring	Check wiring for errors especially the voltage sense wires (chapter 4.2 step 4) Check the fuses
	Fuse (2A) blown	Investigate the cause of the blown fuse. Then replace the fuse (chapter 4.2 step 3)
	Battery voltage less than 7 Volt	Charge the battery
Data from battery bank 2 or 3 is not displayed	Battery bank name is set to "NOT USED" or "AUTO BACKLIGHT"	See chapter 5.2 and 9.1 to adjust the battery bank name
Time remaining function indicating "--:--" during discharge	Shunt wiring reversed	Check installation drawing and correct the wiring. Pay extra attention to the distinction between battery side and load side (chapter 4.2 step 4)
No accurate time remaining function	Wrong setting of the nominal battery capacity	Refer to chapter 5.2 or 9.3 for the correct setting of the battery capacity.
	Wrong setting of the Peukert exponent	Refer to chapter 10.5, 10.11 or 10.14 for the correct setting. See chapter 11.3 for additional information
No accurate reading of State of Charge function	Wrong setting of the nominal battery capacity	Refer to chapter 5.2 or 9.3 for the correct setting of the battery capacity.
	(battery bank 2 and 3 only) Wrong setting of the nominal charger current or average discharge current	Refer to chapter 9.4 or 9.5 for the correct setting of the nominal charger current or average discharge current.
	Wrong setting of the Peukert exponent	Refer to chapter 10.5, 10.11 or 10.14 for the correct setting. See chapter 11.3 for additional information
	Self discharge of the batteries which was not recorded by the <i>Masterlink BTM-III</i>	Recharge the batteries for at least 24 hours
	No failure; note that the accuracy and the resolution of the State of Charge function of battery bank 2 and 3 is $\pm 20\%$	



Failure	Possible cause	What to do
SOC not displayed for battery bank 2 or 3	Visualisation of SOC for battery bank 2 + 3 is set to "OFF"	See chapter 10.16 to enable the visualisation of SOC for battery bank 2 + 3
Calculated Charge Efficiency Factor (CEF) is too low	New installed batteries	Nothing (wait 5-10 cycles). With new installed batteries the charge efficiency may increase during the first 5-10 cycles.
	Batteries have been left standing without being used for a longer period	Recharge the batteries up to 100%.
Battery is fully charged but SOC function does not show "100%"	Charging system has not met the conditions for a fully charged battery	See chapter 11.4 for an overview of the conditions of a fully charged battery.
State of Charge does not return to 100% after a long period of charging	Wrong setting of the float voltage	Lower the setting of the float voltage of the <i>Masterlink BTM-III</i> by 0.1V. See chapter 10.8
Wrong battery name of the battery bank is displayed	Settings error	See chapter 5.2 and 9.1 to adjust the battery bank name
Wrong language is displayed	Wrong setting of the language	Refer to chapter 5.1 or 10.2 for the correct setting of the language.
Impossible to change the language due to understanding problems	Wrong setting of the language (user does not understand the displayed language)	Disconnect the DC-power supply of the <i>Masterlink BTM-III</i> and then reconnect. Default language (English) is shown now. Then follow the steps as described in chapter 5.1.
Parameter settings can not be changed at the settings menu	Lock mode is activated every time you leave the settings menu.	Switch off the lock mode (see chapter 10.1)
Back light and LED-bar switch off after 60 seconds	Unit in energy saving mode	Press one of the buttons or refer to chapter 10.3 to disable the energy saving mode.
Back light and LED-bar do not switch off after 60 seconds while energy saving mode is enabled	Energy saving mode is denied when battery bank name is set to "AUTO BACKLIGHT"	Change the name of Battery bank 3. See chapter 9.1
Alarm function not functioning (correctly)	Wrong setting of the parameters	See chapter 9.7 till 9.13 for the correct setting of the parameters.
	Alarm function is switched off	Switch on the alarm function (chapter 9.6)
	Wrong connection of relay contact	Connect the external relay to the correct pins (chapter 4.2, step 5)
Alarm function is triggered by a short time voltage dip	Wrong setting of the alarm delay time.	Increase the delay time (see chapter 9.9)
Alarm function is still active while the batteries are fully charged again	Minimum runtime hasn't elapsed yet.	See chapter 9.12 to adjust the minimum runtime of the alarm function
MasterAdjust software shows error "no devices found"	NMEA mode is switched to ON	Switch NMEA mode to OFF.(chapter 10.19)
	No PC-link connected	Check user's manual of the PC-link
	COM port on PC used by another software package	Read user's manual of the MasterAdjust software to correct.

## 13 SPECIFICATIONS

### 13.1 TECHNICAL SPECIFICATIONS

Model	Masterlink BTM-III
Article number	70403163
Delivery includes:	Panel, grey installation housing, shunt, user's manual
Function of instrument	Battery monitor for three independent battery banks (12/24V DC)
Manufacturer	Mastervolt Amsterdam the Netherlands
Number of battery sets	3
Voltage Measurement	7-35 V (0.1V resolution)
Voltage accuracy	± 0,6 % ± 1 digit
Current Measurement	0-500 A, 0.2A resolution (0...42A) 2A resolution (42...500A)
Current accuracy	± 0,8 % of reading ± 1 digit
Amp Hours Measurement	0-2000 Ah (1 Ah resolution)
Time remaining	0-480 hours (1-min resolution)
State of charge accuracy:	± 1% (battery bank 1); ± 20% (battery bank 2 and 3)
Readout:	By means of LED bar and LCD display
Available languages:	ENGLISH, NEDERLANDS, DEUTSCH, FRANCAIS, CASTELLANO, ITALIANO, NORSK, SVENSKA, DANSK, SUOMI.
Supply voltage	8-50 V DC
Supply current	100mA(@12V) / 50mA(@24V) Normal operation mode 28mA(@12V) / 16mA(@24V) energy save mode
Shunt	500 Amp / 50 mV (included with the delivery; 1000 Amp / 100 mV available as option)
Battery alarm contact	Yes, open collector
Dimensions	See chapter 13.2
Dimensions shunt:	84 x 44 x 44 mm - M8
Weight	250 gr (excl shunt) 900 gr (incl shunt)
Dept required	65 mm minimum

13.2 DIMENSIONS

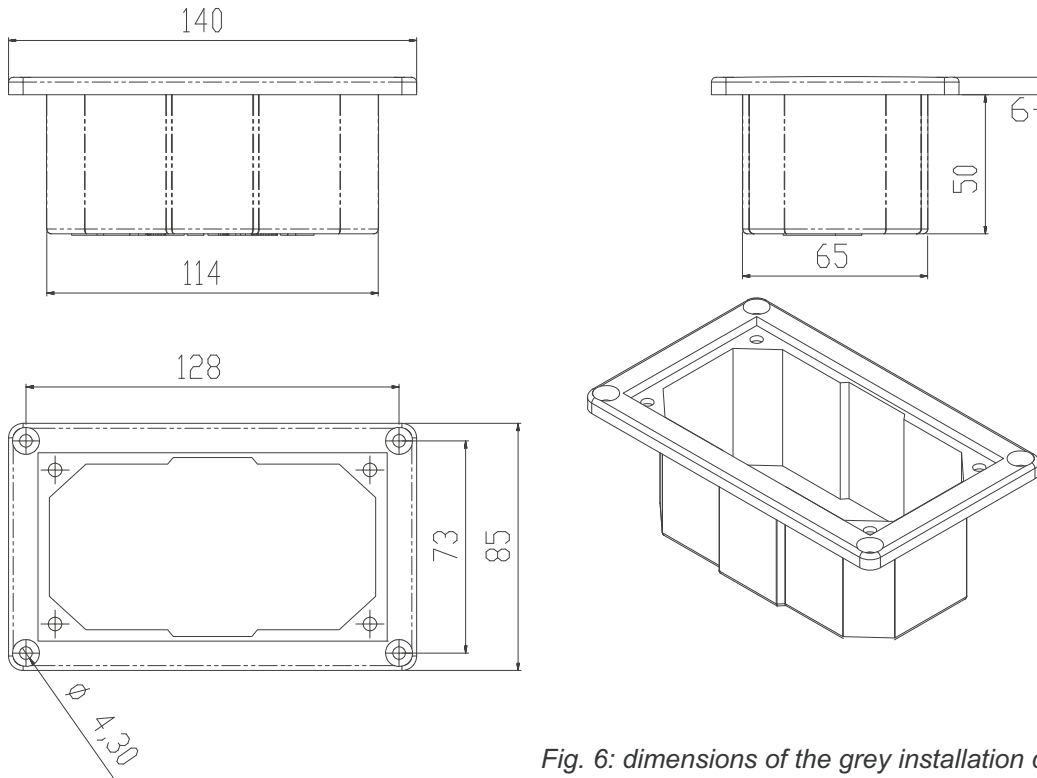

Fig. 6: dimensions of the grey installation cover  
All dimensions are in mm

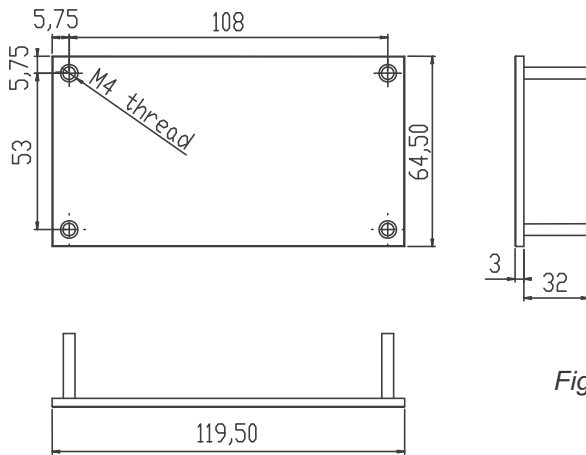

Fig. 7: dimensions of the Masterlink BTM panel  
All dimensions are in mm

## 14 EC DECLARATION OF CONFIRMITY

Manufacturer Mastervolt  
Address Snijdersbergweg 93  
1105 AN Amsterdam  
The Netherlands



Herewith declares that:

Product:

70403163 Masterlink BTM III (12/24V)

Is in conformity with the provision of the EC EMC directive 89/336/EEC and amendments 92/31/EEC, 93/68/EEC.

The following harmonised standards have been applied:

Generic emission standard: EN 50081-1:1992

Generic Immunity standard: EN 50082-1:1997

Safety directive 73/23/EEC and amendment 93/68/EEC, with the following standard:

Low voltage standard: EN 60950: 2000

Amsterdam,



R.J. ter Heide,  
General Manager MASTERVOLT