

FIRST ANGLE PROJECTION

REMOVE ALL BURRS AND SHARP EDGES

ISSUE	REVISION	MOD No.	DATE
F	SEE MOD NOTE	10503	18-Jan-07
E	SEE MOD NOTE	10480	11-Jan-07
D	SEE MOD NOTE	10392	27-Nov-06
C	SEE MOD NOTE	10377	21-Nov-06
B	SEE MOD NOTE	10232	31-Aug-06

BASIC DIMENSIONS OF GALVANISED DELTA ANCHOR

	A	B	C	D	E	F	G	ØH	I	J	K (kg)
4 kg	217	514	230	8	210	387	4	8	116	71	1.5
6 kg	254	593	265	10	243	450	4	10	148	81	2.7
10 kg	293	695	310	12.5	282	526	5	10	172	95	4.0
16 kg	339	812	362	12.5	328	614	5	12	205	114	6.1
20 kg	370	877	392	16	357	663	6	12	225	123	8.0
25 kg	397	945	415	16	387	713	6	12	245	135	9.9
32 kg	425	1023	453.5	20	425	775	8	16	254	142	10.8
40 kg	461	1099	489	20	435	833	8	16	265	154	13.7
50 kg	486	1175	523	20	479	890	8	16	282	158	18.2
63 kg	537	1270	567	22	508	963	8	25	290	171	24.6

BASIC DIMENSIONS OF ST/ST DELTA ANCHOR

	A	B	C	D	E	F	G	ØH	I	J	K (kg)
6 kg	254	593	265	10	243	450	4	10	148	89	1.6
10 kg	293	695	310	12.5	282	526	5	10	172	104	2.8
16 kg	339	812	362	12.5	328	614	5	12	205	114	6.1
20 kg	370	877	392	16	357	663	6	12	225	122	6.0
25 kg	397	945	415	16	387	713	6	12	245	121	8.8
32 kg	432	1028	446	20	407	774	8	16	250	143	6.5
40 kg	461	1099	489	20	435	833	8	16	265	164	10.7
50 kg	486	1175	523	20	479	890	8	16	282	167	17.2
63 kg	537	1270	567	22	508	963	8	25	290	185	18.3

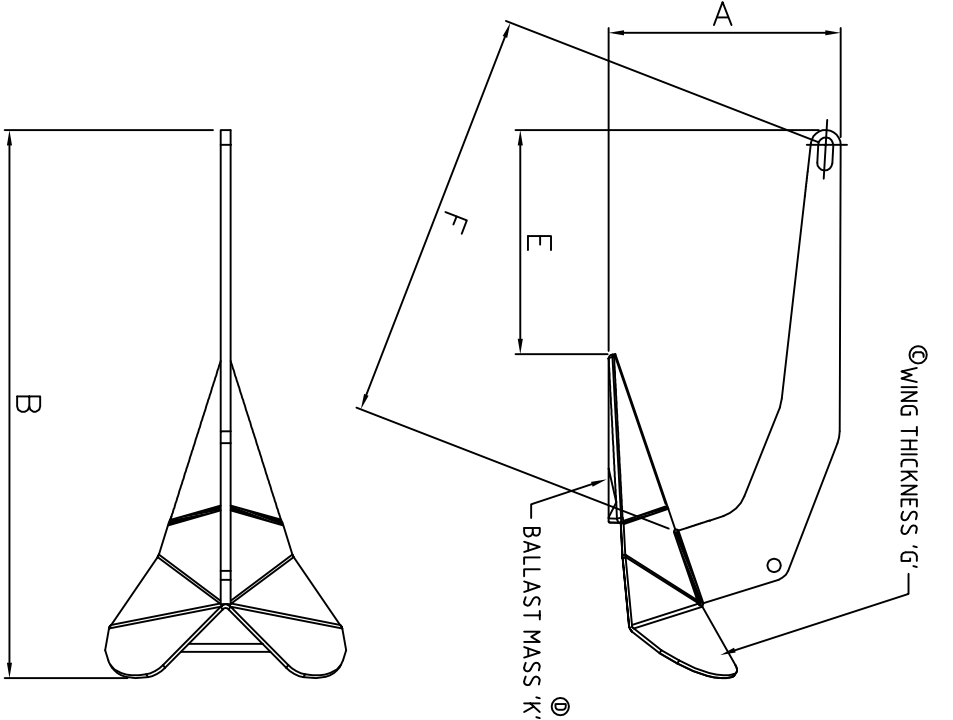
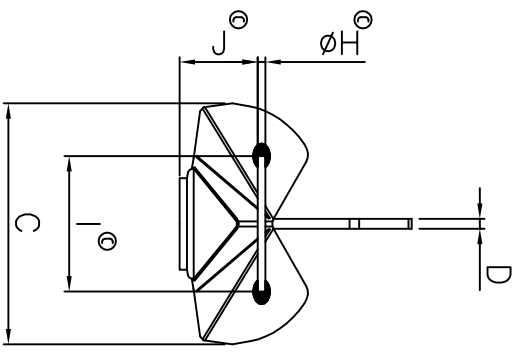

PART No. 60000431

ORIGINAL SIZE A2
 REFERENCE SCALE IN MM
 0 10 20 30 40 50

Unauthorized use, manufacture or reproduction
 In whole or in part is prohibited

NOTE:
 FOR GALVANISED ANCHORS - STEEL BALLAST IS WELDED DIRECTLY TO WINGS.
 FOR ST/ST ANCHORS - LEAD BALLAST IS HELD INSIDE WELDED CHAMBER.

MATERIAL	ALL DIMENSIONS IN mm	DRN	TITLE
FINISH	TOLERANCES (AS STATED)	MD	DELTA ANCHOR SPECIFICATION
	DATE 17-July-06		PART No. 60000431
	SCALE NTS		LEWIS